

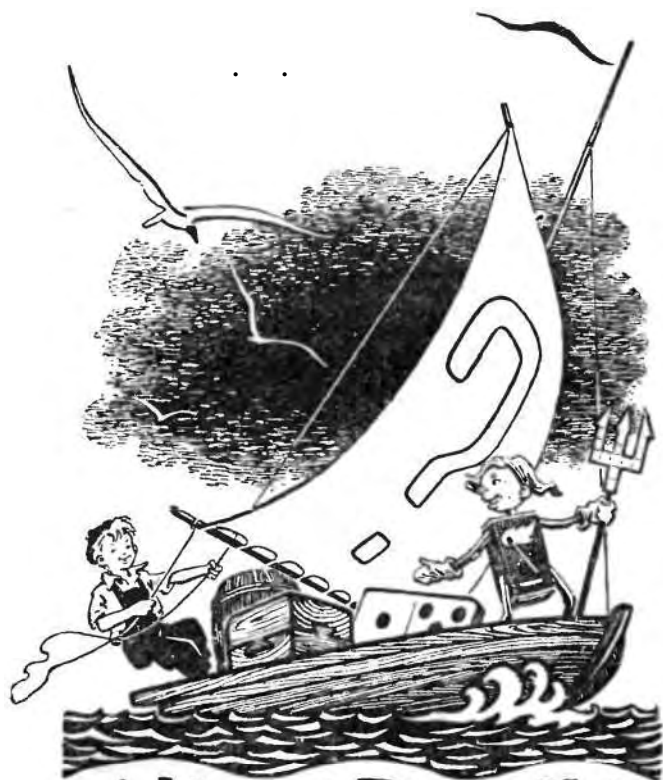

Я. И. ПЕРЕЛЬМАН

**ЗАНИМАТЕЛЬНЫЕ
ЗАДАЧИ И ОПЫТЫ**

ДЕТГИЗ · 1959



ЗАНИМАТЕЛЬНЫЕ
ЗАДАЧИ И ОПЫТЫ



1. 1994年10月1日以前签订的合同，在1994年10月1日以后履行时，应当适用1994年10月1日以后颁布的《合同法》。

2. 1994年10月1日以后签订的合同，在1994年10月1日以后履行时，应当适用1994年10月1日以后颁布的《合同法》。

3. 1994年10月1日以后签订的合同，在1994年10月1日以前履行时，应当适用1994年10月1日以前颁布的《合同法》。

4. 1994年10月1日以前签订的合同，在1994年10月1日以前履行时，应当适用1994年10月1日以前颁布的《合同法》。

1913

« ... ».

« ... »

« ... 11 ... » —

« ... »

« ... 1945 ... 1882 ... 15 ... »

1909

« ... »

: « ... », « ... »

», « ... », « ... », « ... »

», « ... »

», « ... (« ... »)..

« . . . »: « -
-
-
-
-
».
« — »,
« — »
16 « 1942 ».



— ?
— !
— ,
— , —
— :
— !
— ?
— !
— ! —
— ,
— ,
— ,
— !
— ,
— ,
— ? — ,
— , —
— !
— ?
—

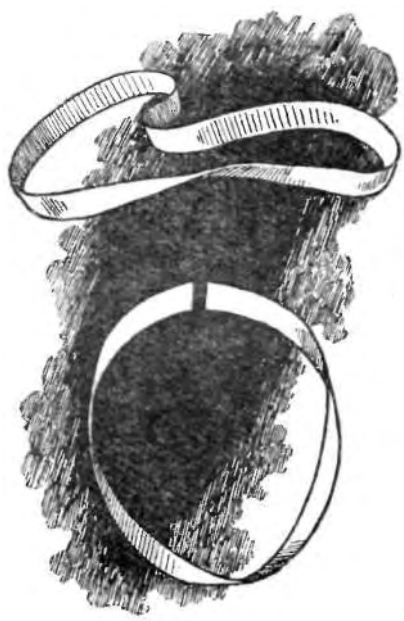

.3.

— , . , ?
— ! ,
— , , ? —
— : .
— , ,
— ! :
— , — . —
— , ,
— ! ? ...
— ... , ,
— , .

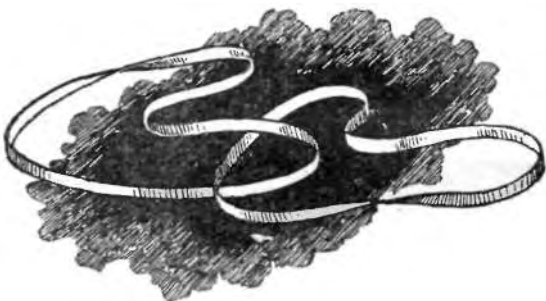

.4.

— , — . — ?
— ! ,
— .

— , — , — ,

— ? :

, ,

— ? , — , —

— ? , — ? .

— ? !—

!— .

— , , .

— !—

— , , !— .

— , , ?—

— !

— ? ! ,

— .

— ... , —

— , ,



.5.

— , — ,
 — !
 — :
 — ? : ?
 — !—
 — ,
 ..
 ?— . — . — ?
 — . — . —
 — , —
 — ?

— :
— . ' ?
— ?
— ,
— ?
— ?
— ?
— :
' («
)
— —

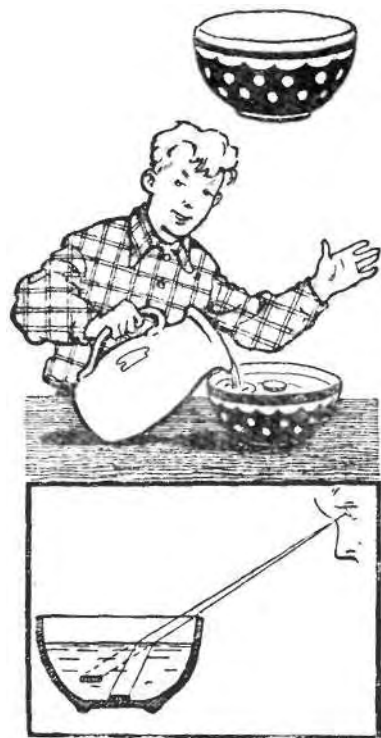

.6.

75

1

?

?

15

12

— , —
 — 15 , ? —
 — 15 ,
 — , ?
 — :
 — , — :
 — 15 ? , ,
 — ? , 16
 — ?
 — : 100 × 100 = 10 000. 100?
 — ; — 16 , —
 , ? 16 ,
 — , 20 ?
 — , , , !
 — , — 11
 10 ? ,
 — ?
 — 10 , — ,
 — ?
 — 11 , 10 , ... ,
 — , —

— , , 11 —
 — , ?.. —
 — , 10
 10 — , 11 —
 — , 10 —
 ... 11 ! , 10 —
 — , , —
 : , —
 — , —
 — , —
 — , —
 — , — ?
 — ! , :

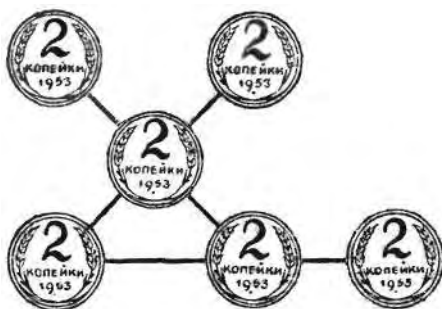

— , —
 . —
 — ? . , —
 — , , .
 — : 10
 . : 10
 . 36
 18 ,
 ,
 ... ,
 1, — ,
 , ,
 : , ,
 — , , ?
 — , , ?
 — , , —
 — , , —
 : , , 2,
 — , , :
 : , , :
 , , —
 1 « »—3 —). 15 (—
 2 — 50 .

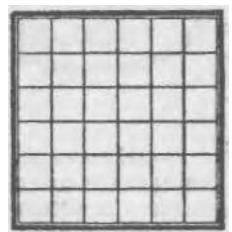

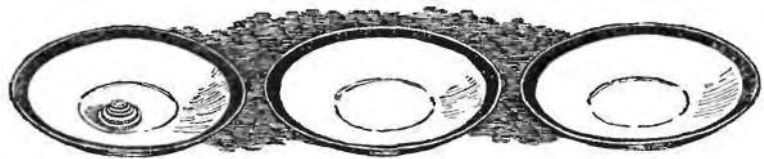

. 9.

— ? —
— —

?

— ? —

—
—

— ?

— :

— — —

—
 $3 + 1 + 3 = 7.$

—
 — — ; , 3 : 7 + 1 + 7 = 15.
 — 15 + 1 + 15 = 31.
 — ,

, 3, 7, 15, 31 — . ; -

! —
 $3 = 2 \times 2 - 1,$
 $7 = 2 \times 2 \times 2 - 1,$
 $15 = 2 \times 2 \times 2 \times 2 - 1,$
 $31 = 2 \times 2 \times 2 \times 2 \times 2 - 1.$
 — :

2 × 2 × 2 × 2 × 2 × 2 × 2 — 1 = 128 — 1 = 127.

— ? , : — . -

— , , ; , -
 . , , -
 : , 64

, , -
 , : , -

— , 64 , , !
 — , , , ? 64

— 3600 ,

— ?
 — — 100 . 10 — -
 64 , . , , -
 — 500 ! 64 , -
 — ? - -
 — « 64 » 18 , ... , .
 — , . .
 — , — , 16 , , , ,
 — 65 536 — , , , , ,

18 446 744 073 709 551 616.

, , ...
 , , -
 , , -
 . 11 10 , -
 : ; -
 ; ; -
 , ! . ?
 , , : 15 ; -
 , , ; 15 -
 , , 15 , -
 , , , , -

(. 10).

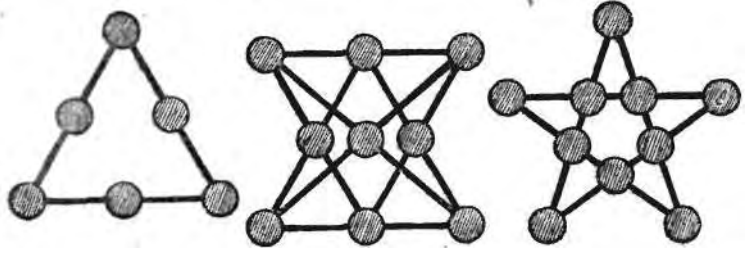



. 11.

36 (. 11): 18

— ? —
 — ? —
 — ? —

« ! »

— , — — — —

, — — — — —

— — — — —

, — — — — —

, — — — — —

... — — — — —

, — — — — —

... — — — — —

, — — — — —

... — — — — —

» — — — — —

— — — — — — — — — — —

, — — — — — — — — — — —

— — — — — — — — — — —

, — — — — — — — — — — —

— — — — — — — — — — —

— — — — — — — — — — —

! — — — — — — — — — — —

? — — — — — — — — — — —

— : !
 — , — , ,
 — ? ? 200
 — : «
 , ... ».
 : 1000
 , -

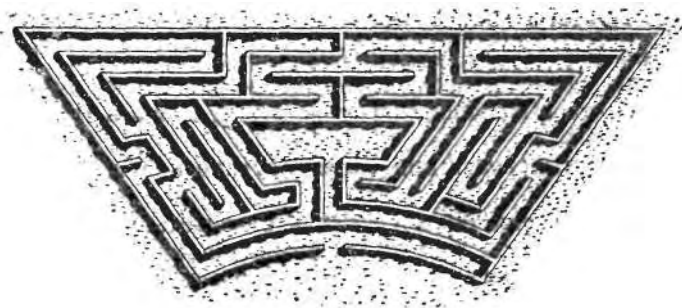

. 12.

— , , ,
 , ? -
 , , ,
 ... ! ,
 — : ,
 — ? ?
 — , ? ,
 , , ,
 , , ,
 , , ,

— , , , ...
 — , , —
 — ?
 — , — , —
 — ?
 — ,
 , , &
 — !
 — , — " ,
 — ,
 — :
 — ?
 —

(. 13),

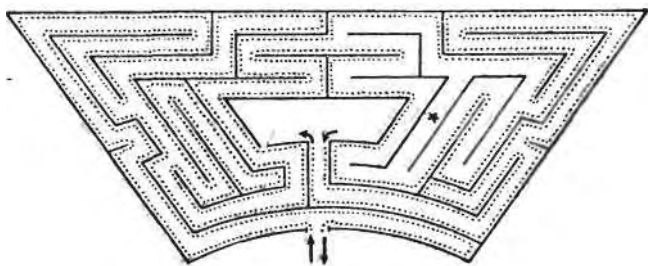

. 13.

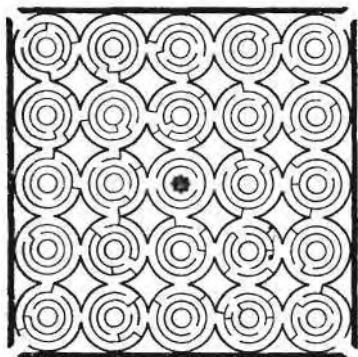

. 14.

, , , -

— ?.. , , -

., , -

., : , -

, , , -

. 200 , , -

, , -

, , , -

, , ? -

, , « -

» : , -

— « , -

1460 , — , — -

... , , -

; , -

, , -

, , -

, , -

, , , -

, , -

— »., , —

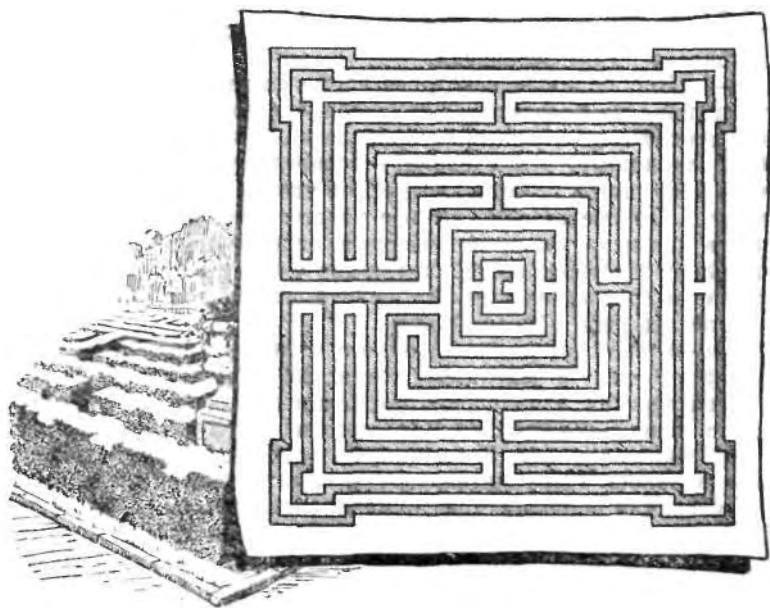



. 16.

(. 14, 15 16).

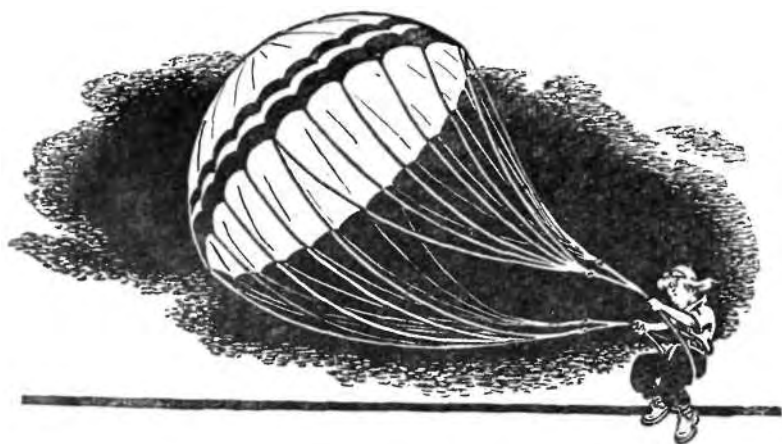

«

:— ,—

».

: «

».

?

?

«

» (

)

?

«



17.

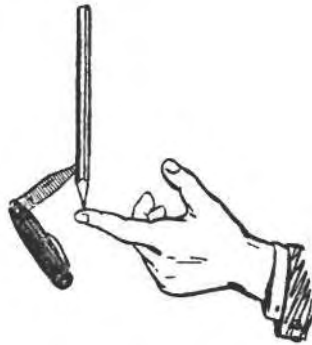

18.



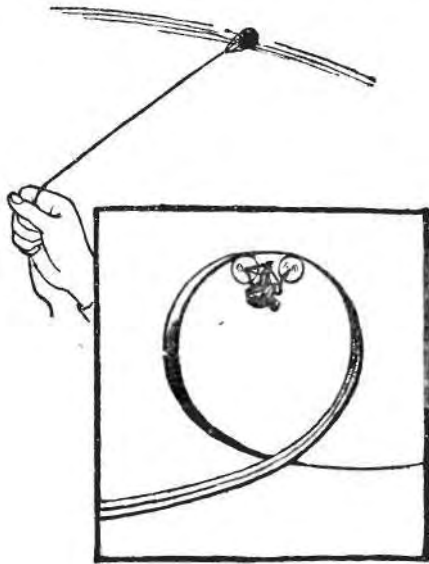

20.

, — , —
 , , — , ,
 , . :
 , , . —
 .
 , — , —
 ? , .
 — , , 24 —
 ; , 5 . , , —
 , , —
 20 60 —
 , — —80 .
 ! ? , , —
 , , —
 » . « —
 , — . —
 ; , 17 , —
 , 1 , — —
 ! , : ,

10

1.



. 21.

2.

3.

23

«

2 (. 22).

4.



. 22.



. 23.



. 24.

5.

6.

() .

(. 24).

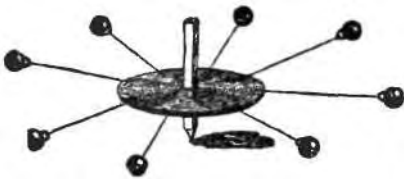

. 25.

7.

(. 26).

8.

(. 27).

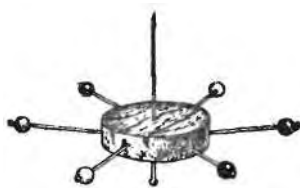

.. 26.



. 27.



. 28.



. 29.

9. (. 28). (. 29).



. 30.

« », « », « », « », « », « », « »...

10. (. 30).



. 31.

(. 31).

: « ».

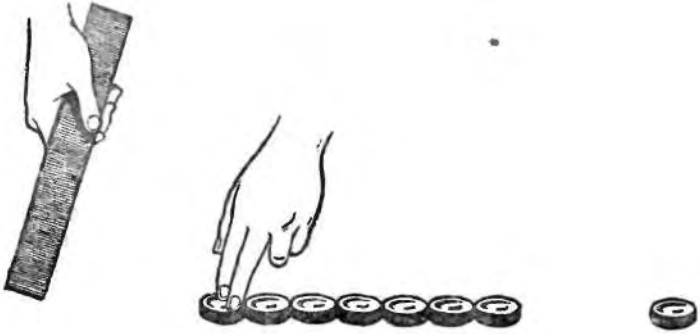

. 32.

(,)

(, —); -

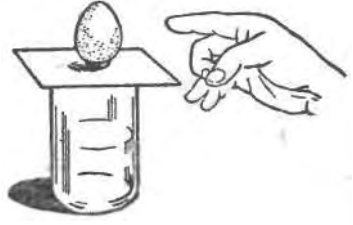

. 33.

),

(—



. 34.

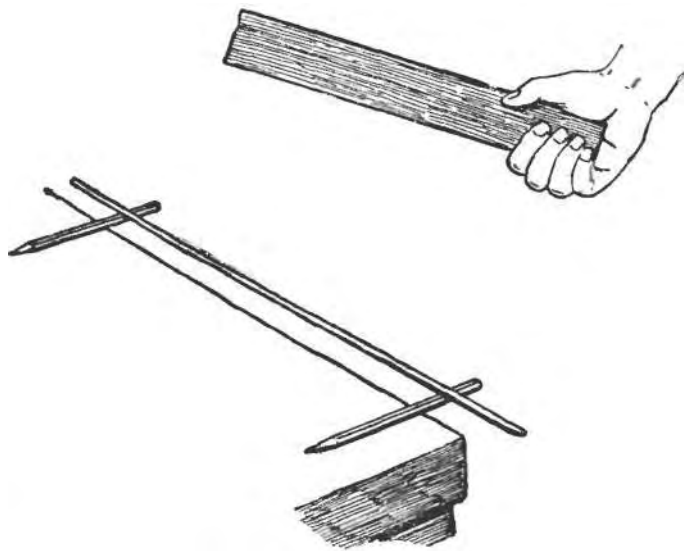

. 35.



. 36.

?

(« »).

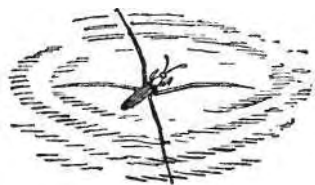

.37.

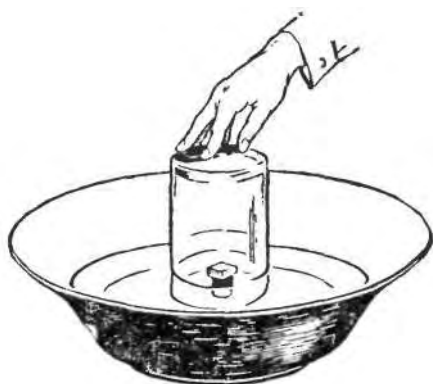

. 38.

?

200



XVI ; « »— (XX) -



. 40.

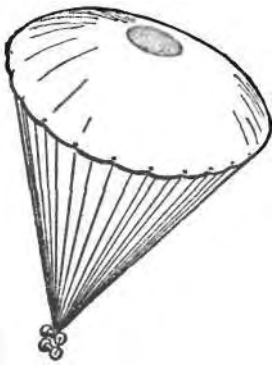

. 41.

— 6000

— 300

— 1500

10

100

1000
1000



.42.

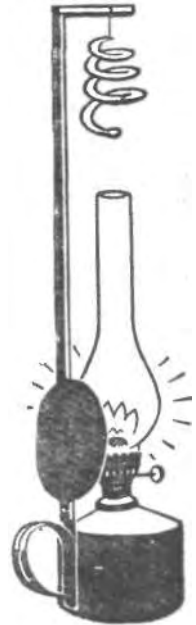

.43.

?



.44.

5

«

».

(

0°).

80

10

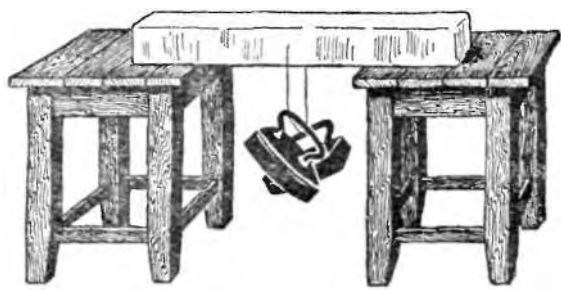

. 45.



.46.

?..—

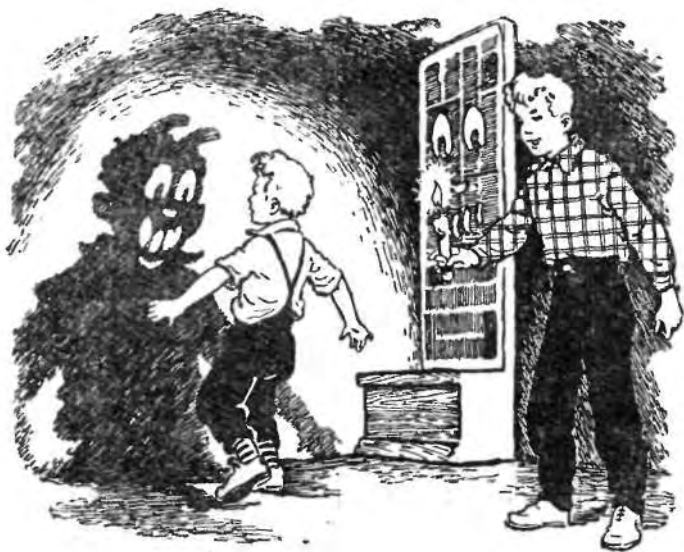

.47.

16

5×5

4×4
25

36

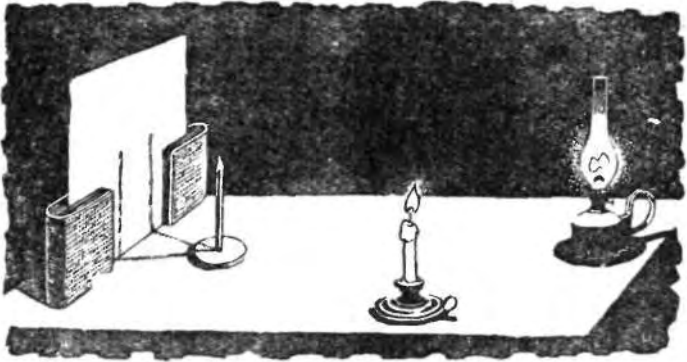

.48.

10

100

3X3,

« » (»).

« ».



. 49.

?

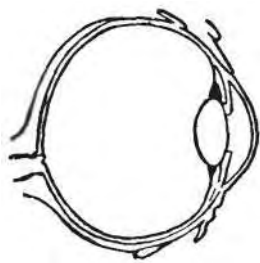

. 50.

10

51



. 51.

, , .
 , , .
 , ; — — —
 — . ()

, . — — —
 , — : —

? — . , , ,
 , . ?

. , — — —
 : ? , , ,

: ? ! , , ,
 , . : — — —

: , . : — — —
 : ; , — — —

— ?
— ,
— :

— !
— ,
— ,

!



. 52.

— !
— ,

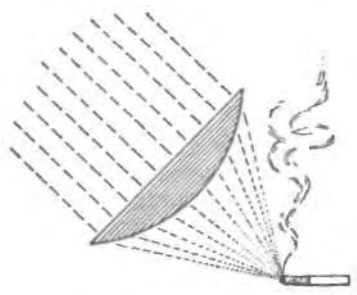

. 53.

— ,
— !



.54.



. 55.



.56.



.57.



.58

— « — » ; « — » .

« »;

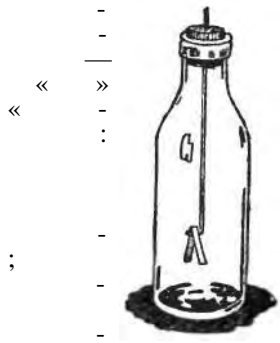

.59.



.60.

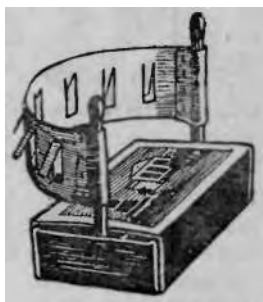

.61.

S,

(. 61)

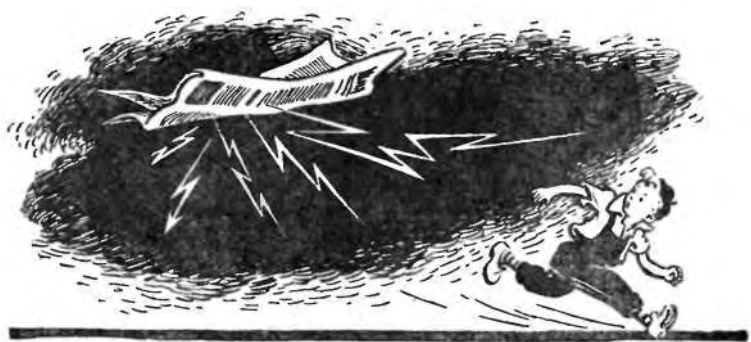

”

“?—

— !— . — , : —
— ? ? !— ! — —
— . ? . — —
— — ? ? — —
— , , , , — —
— , — ? , — —
— , , , , — —

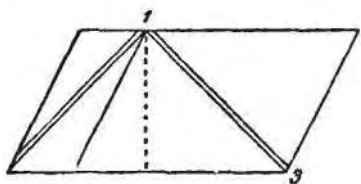
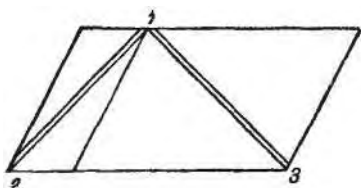

. 62.

2—3. —

— . — ? ? —
— . —
— . —
— . 2 3 , —
— 1? : 2 3? —
— 3. , 2 —
— . —
— . ? ? , —
— . ? , ! . —
— . , , —
— . , : —
— . — ? — , —
— . — ? ? —
— ? , , . —
— . — , . —
— . — , . —
— ? , , " —
— . —
— . ! — , —
— . , . —
— . , : —
— . , . —



. 63.

— , ?—
 .
 — ? ? —
 — , . —
 . , .
 — ? —
 — .
 : .
 , ; —
 . ; —
 : ,
 ,
 , :
 ,
 :

4 16
 16
 , —
 — ,
 —
 ?..
 . — . —
 ,
 — ! —
 :
 — ? — . —
 —
 — ?
 — , , ,
 — , ?
 — ...
 — , , ,
 — : , — !
 ?
 !



.64.

, , -
— , , —
!.. ! , ? :—
,
,
— !— . —
— ? !
— , !
— !
, ,
, ,



.65.



. 66.

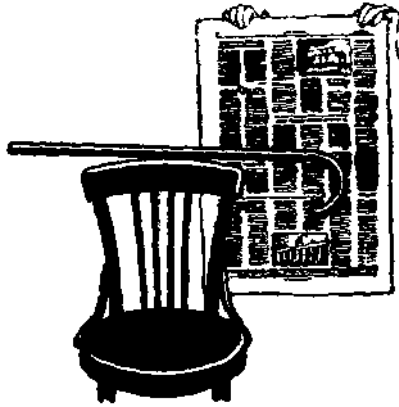

.67.

?

1867

3

« »

«

«

«

10

1863

()



.68.

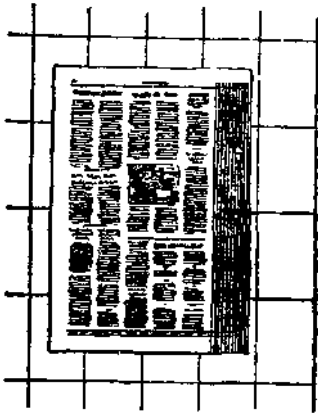

. 69.

« »



. 70.



.71.

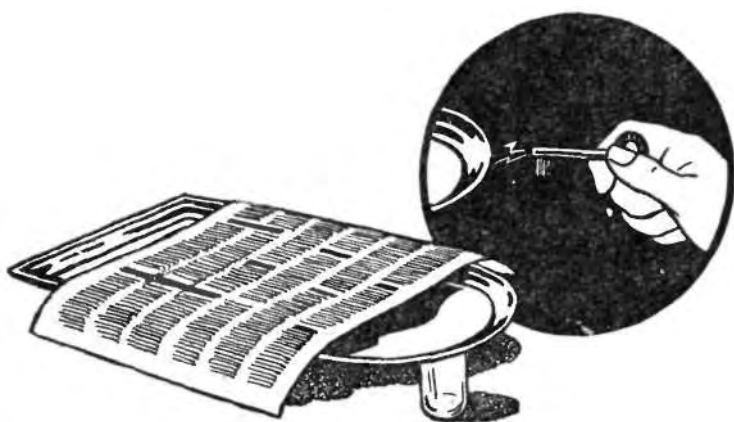

. 72.



. 73.

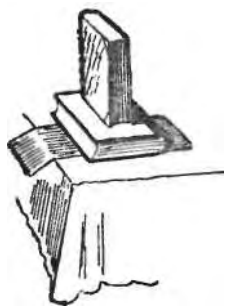

.74.



.74, .

1000

10

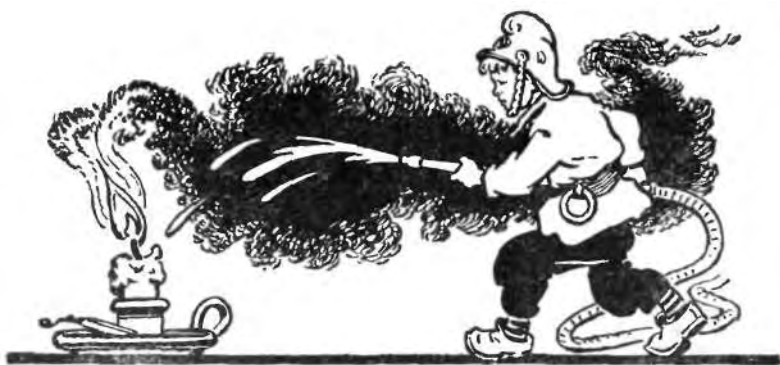

?

?

:

;

,

,

,

,

,

,

,

,

.

,

,

.

:

,

;

,

.

(1) .

100

(. 75).

100



. 75

$$60 \times \frac{20}{120} = 60 \times \frac{1}{6} = 10$$

?

$$20 \times 3 = 60$$

$$120/60 = 2$$

$$24$$

$$32 \times 10 = 320$$

$$16$$

$$3,14 \times 12 \times 12 = 452.16$$

$$10000/452 = 22.12$$

$$1$$

$$16000/804 = 19.9$$

$$20$$

1

(3.14)

? , ,
 ,
 — 1 . . 1 . ,
 1 , 1 ,
 1:0,01=100, 100 1 , 1 . , (—
 = 0,01 .) . ; , —
 , , , ,
 , , : .
 1 . — .
 , —
 ? ,
 , , , ,
 . , , , ,
 1000 — 1 . , , , ,
 , , , ,

10—12



. 76.

?

(. 77)



? —

. 77.

«

».

«

».

10

78.



78.



78.

(78,)

, , « » () , , ,

() ?
? , , ;
, , :
, ;

?

(. 79).



. 79.

?

(. 79) —

36

(

).

?

(.80).

?

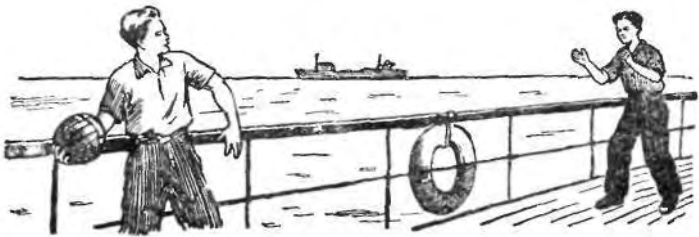

80.

, —
,
, ,
; ,
(,)
?
:
?
:
?
:

. 81.



. 81.

(. 82,),

?

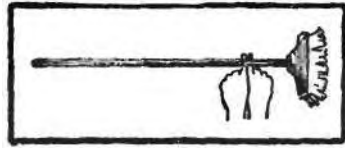

. 82.

10

, , -
 . , , -
 , , -
 , ,
 ;
 .
 , -
 —
 .
 , ,
 . , ,
 ? ,
 ,
 , -
 , -
 , -
 , , -
 . , , -
 , , -
 , -
 : — —
 , , -
 , , -
 . , , -
 . , , -
 , , -
 , , — -
 , , -
 ? , -
 , ,

(. 83).

(. 83).

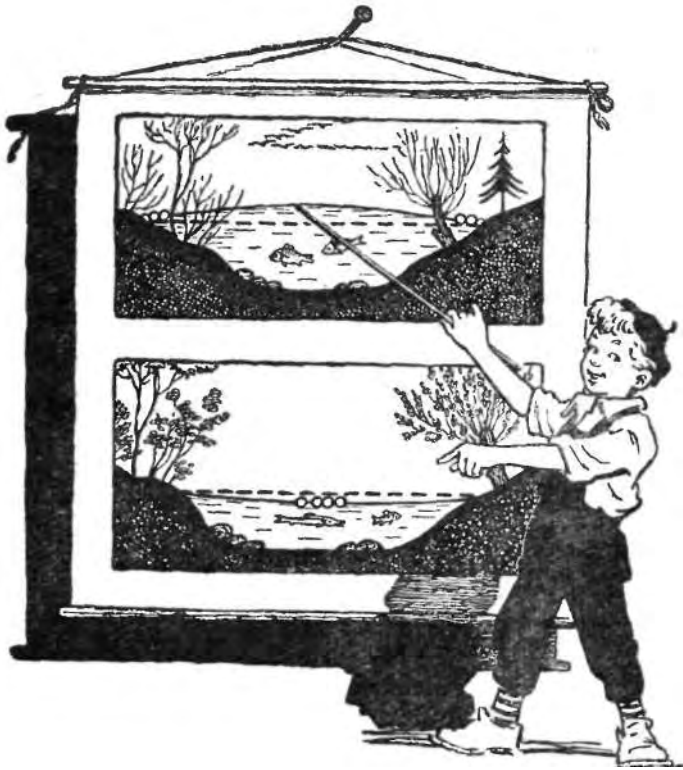



. 84.

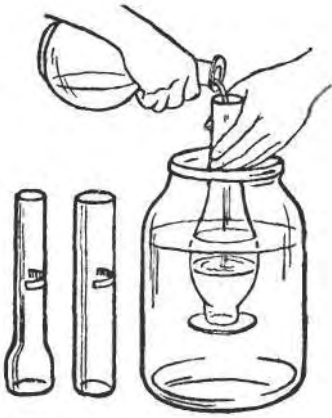

. 85.

(,) .

?

(. 86).
?

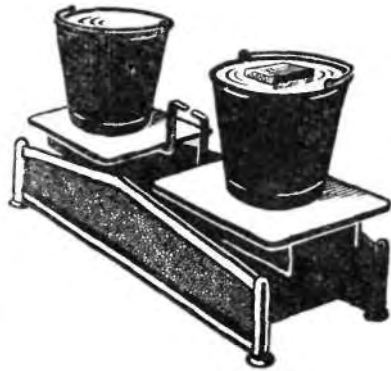

. 86.

() ,

?

?

(1¹⁵)

(.87).

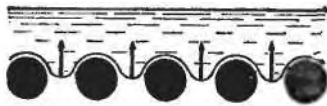

,
 , . , .
 , , . , -
 , . , -
 , -
 — , -
 . , -
 , . -
 , ? -
 , . , -
 — , -
 , -
 ? ; -
 , « -
 — : -
 ».
 , -
 — , -
 , -
 . , -
 , -
 » «
 , .

1, , -
-
7 (). -
10 , -
2-3 ; -
. 88, -

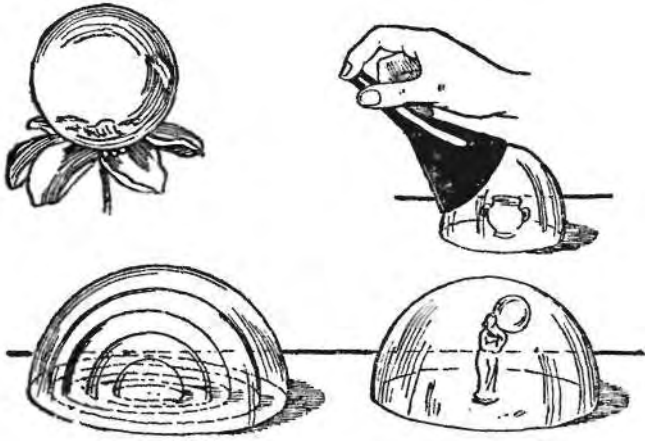

. 88.

(. 89)



. 89.

(. 89).

$$1000 \times 30 \times \frac{1}{273} =$$

110 . .

$$1000 \begin{array}{l} -15^\circ \\ \gg \\ - \\ +15^\circ \end{array}$$

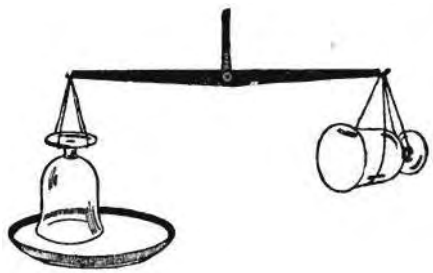

. 90.

?

, , , , ? -
 ? -
 ? -
 , , , , -
 , , , , .
 . -
 1000 ; (,) $1\frac{1}{5}$. 1000 ,
 $1\frac{1}{5}$; $1\frac{1}{5}$. ,
 , , , ,
 15 . , 3 , $15 \times 3 = 45$. .
 , $\frac{45}{54}$, $\frac{1}{5}$ 45, 9 ,
 , , .
 , , , , -
 , , , , -
 , , , , -
 . -
 , — . —
 . ! , ...
 , , , , :
 . ,

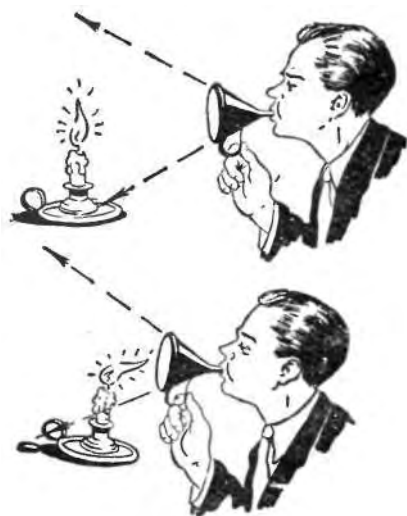

. 91.



. 92.

. , , -
 . , -
 , . -
 , -
 , , , -
 , ? , : -
 , . -
 , , -
 . : , -
 , . -
 ? , . -
 . ? ? -
 . , , -
 , , , -
 ? ,

(, ,) , ; -
, , , . , -
, , , , ;
, , , . , ;
, , . , ;
, , , , ;
, , , . , -
, , , , ;
, , , , . -
, , , ? , ? -
, ? , -
, , , , , , , ; « », -
, , . -
, , , , ? -
, , , ? ' , , -
, , , . , -
, , , , , -
, , , , , -
, , , , . -
, , , , , -
, , , .

— 70 —

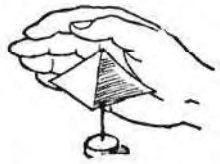

. 93.

?

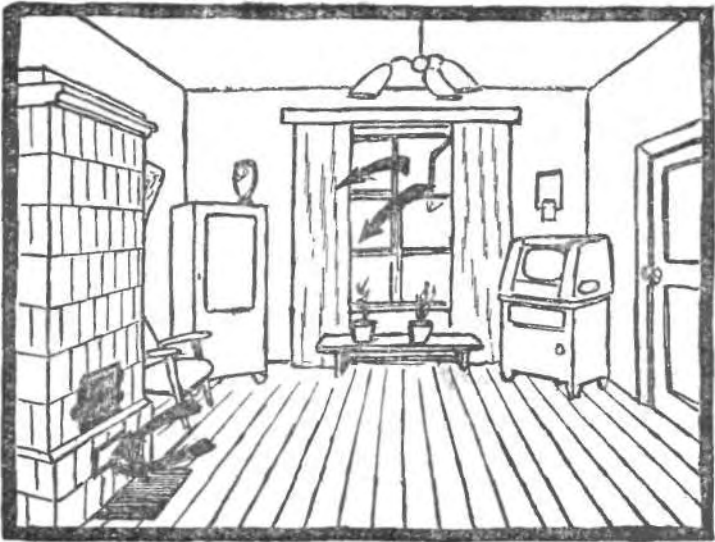

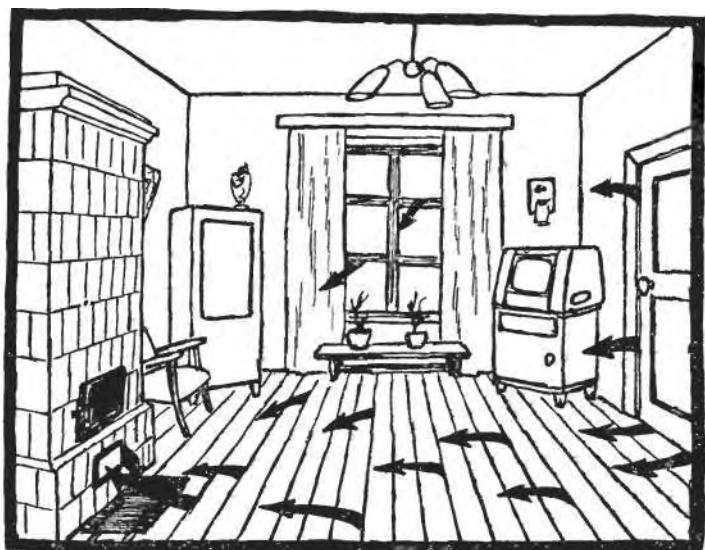

. 95.

. 96:

100°;

100°;

. 96,



96.

335° ();

?

(1452—1519),

?

« ».

: «

».

?

, ? -
 : , ? -
 , , -
 : , , -
 . ? ? -
 , ? , -
 . , -
 , , -
 (,), -
 , , -
 . , -
 , ? , ;
 , , .
 ?
 . -
 , , , , -
 , , -
 ; , , -
 , 100° -
 , , , ; , -
 , , , -
 . , -
 ... ! , , -

100°, (500 , ,).

? : , - ; -

? , -

, , -

100°, — , , -

? , -

« » — , -

, , -

— , -

97, , -

... , , - ; -

1 — 1 1°.



. 97.



. 98.

(. 98),

?
 ,
 . «
 ,
 » (—
 « , »). , ,
 , , .

?
 , «
 ».
 ;
 ?
 5
 6
 20 , 30 .
 60 16 .

,
 ,
 ; « »,
 33',
 33 , ? 66 , 33 66:330,
 $\frac{1}{5}$, $\frac{1}{5}$,
 ; — « », « »—
 $\frac{1}{5}$; 33
 ; ,
 ; ,
 « », « »?
 $\frac{1}{5}$;
 $\frac{2}{5}$, —66 — $330 \times \frac{2}{5} = 132$.
 ,
 ,
 ,
 , 99 ,
 16 ; — ,
 ; ,



Рис. 99.

?

15—20

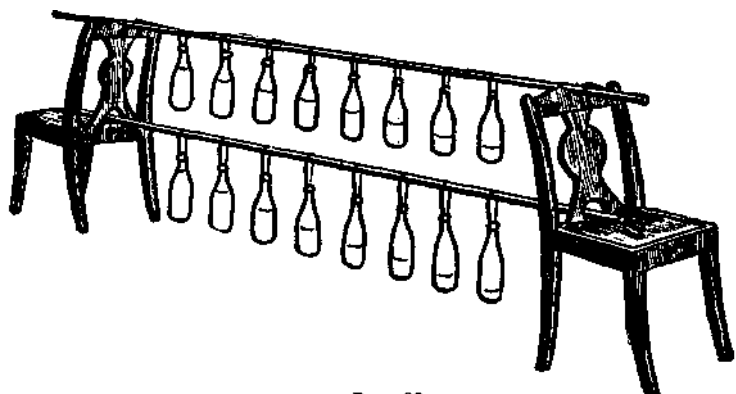

. 100.

(, ,).

?

$$\begin{array}{r}
 5 \\
 200 \cdot \\
 \quad 300
 \end{array}$$

= 100 ,

$$\begin{array}{r}
 600 \\
 600 \cdot
 \end{array}$$

;

$$5 \times 60 = 300$$

$$\begin{array}{r}
 100 \\
 200 - 100 = \\
 \quad 300
 \end{array}$$

?

99

100



. 101.

1—2%! (1 % , 400 000) 100% 1% 80%

?

, 100% , -
 , -
 , , -
 , (, -
 — 91%). — -
 , , -
 400 000 , , -
 , , -
 , -
 ? -
 ? , -
 , -
 — , -
 , , -
). (, -
 , , -
 , — . -
 , , -
 : , -
 , , -
 , . -
 ? -
 , , -
 , , -
 , , -
 , , -
 , — -



. 102.

(0,0005),

137



XVIII
;—
.

, , ; : -
; , -
, -
, , -
, -
/» , -
, , -
, , -
, , -
1. -
, -
, -
, -
, -
- , -
, -
, -
, -
, -
, -
, -
; , -
: , (), -
, , -
, -
, - (-
, -)).

. 144: ,
, ,
, -
(

1
1
(1911); , : . . . -

... (). « , -
» — , -
« », , « , -
» . (.
. 144), , :
, -
. , -
: , -
, ; -
, , , -
, . , -
, -
; -
. , , ,
. , , ,
, , ,
(,). -
, , , , ,
, , , , , , , ,
: , , -
, , -
... , -
.

(... 103—110).

XVIII

2

9

4

«...»
»

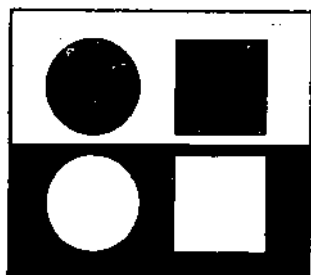

. 103.

. 104.

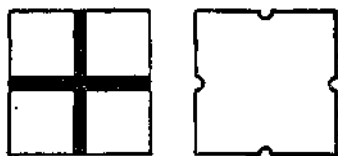

. 105.

20—25

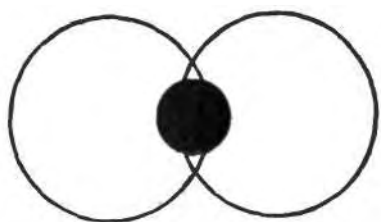

107.



?

45

90°

,

).

(

,

┌

-

.

. 108.

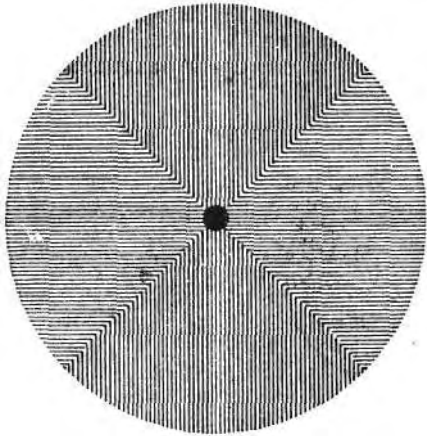

)

(

-

-

-

-

-

-

-

-

-

.

),

,

,

,

,

. 109



,

.

-

-

-

(

).

146

. 110

(
).



. 111.

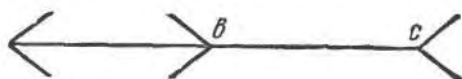

. 112

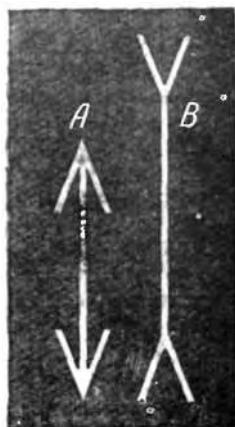

. 113

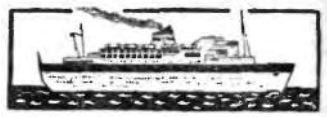
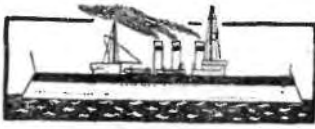

. 114



. 115

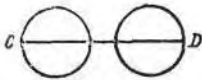

CD.

. 116

).

(

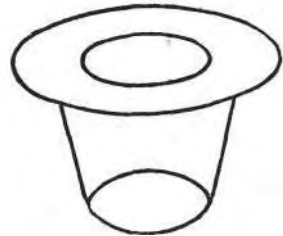

. 117

$CD \parallel EF$
()

),
()

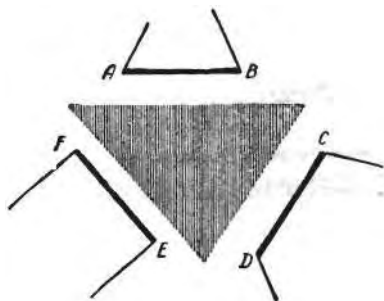

. 118

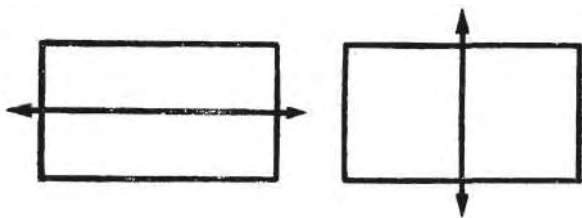

(),

. 119

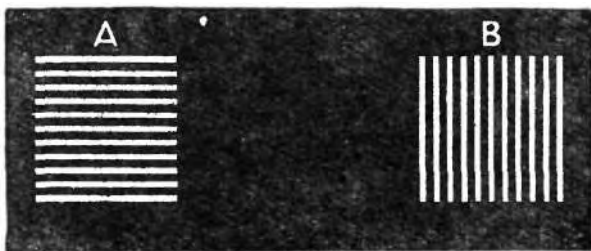

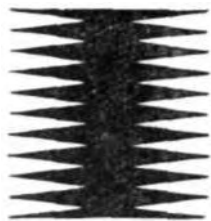

. 120

. 121

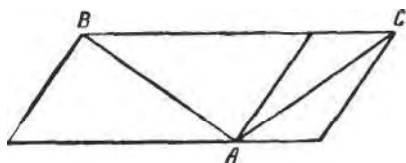

. 122

. 123

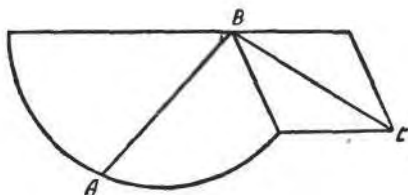

. 124

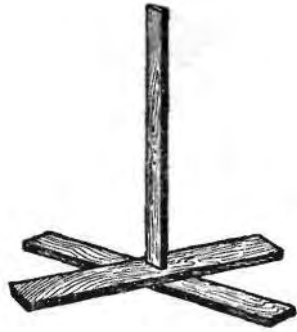

. 125

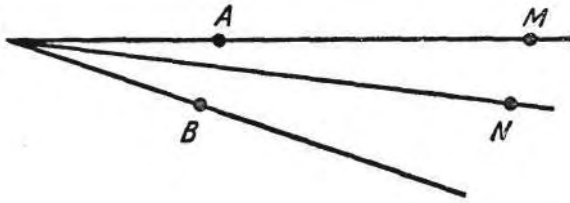

MN

. 126

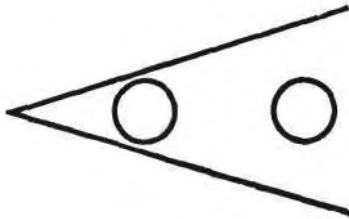

151



. 127

CD.



. 128



. 129.

„

”



. 130.

X38S

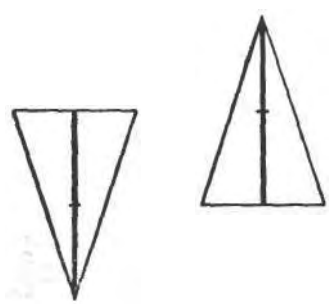

. 131

. 132.



. 133

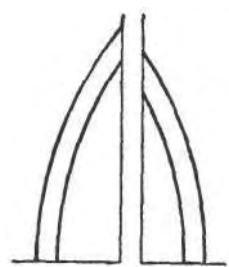

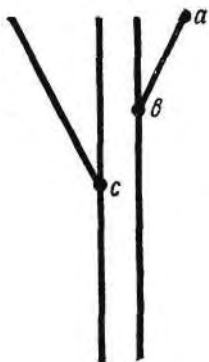

. 134

. 135

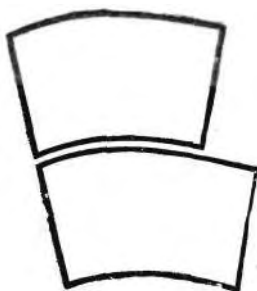

. 136

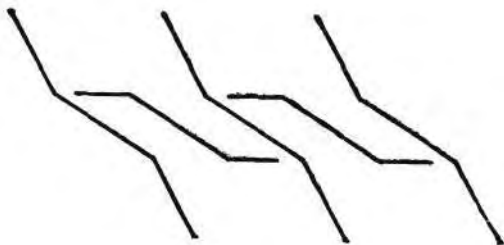

154

. 137.

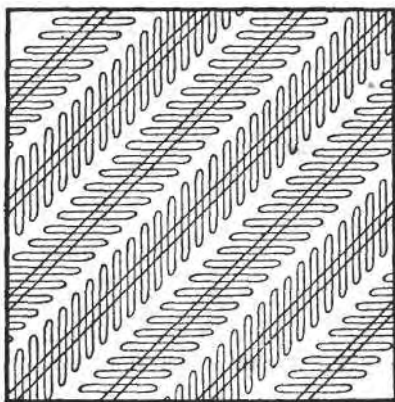

. 138.

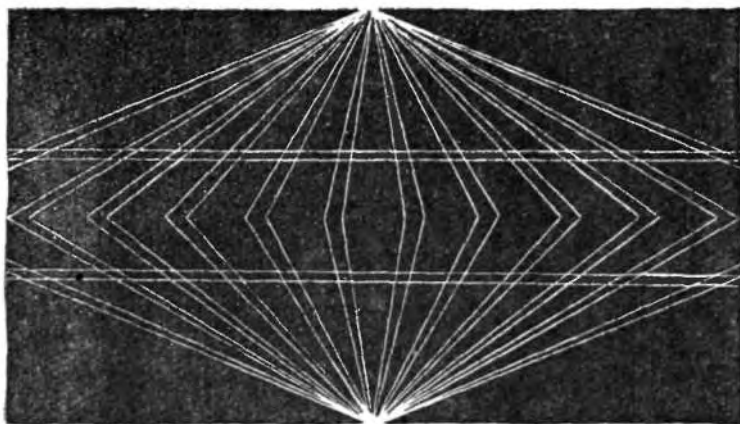

;
; 2)

: 1)

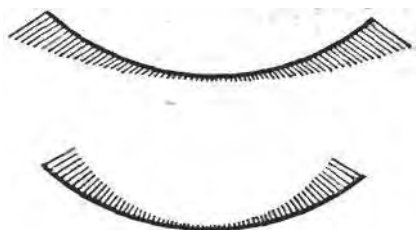

139

140

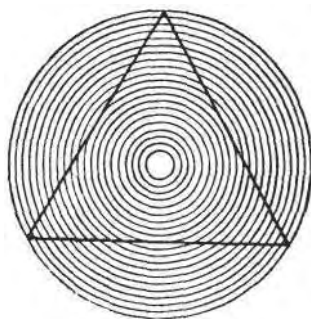

141

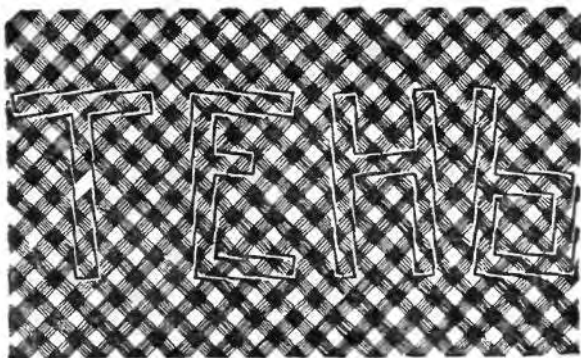

156

. 142

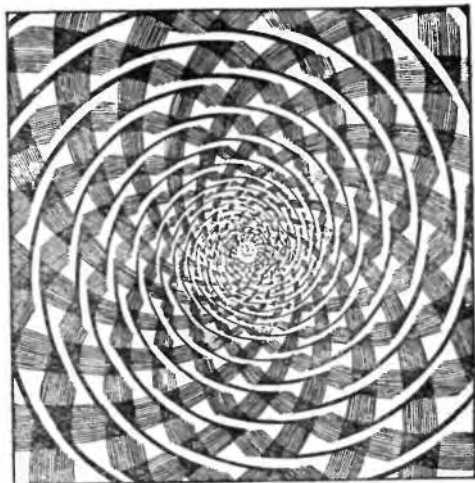

. 143

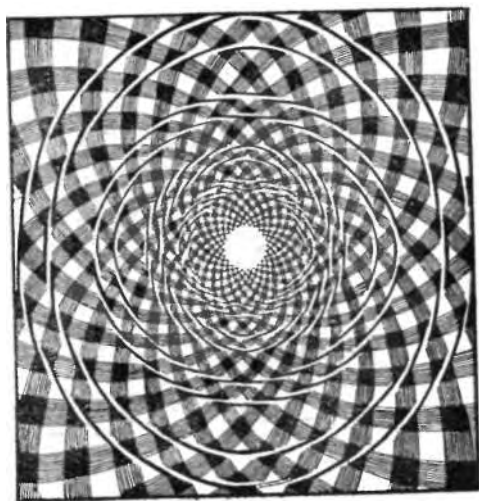

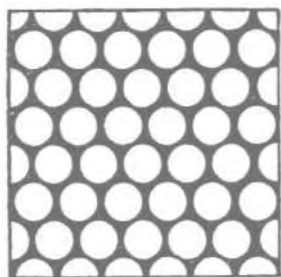

)



(

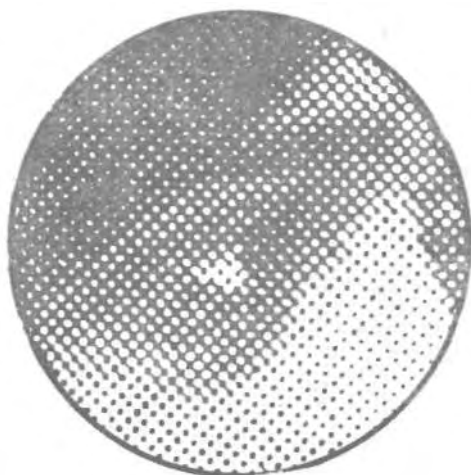

),

10

(

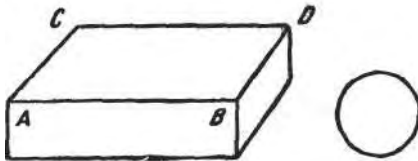

CD?

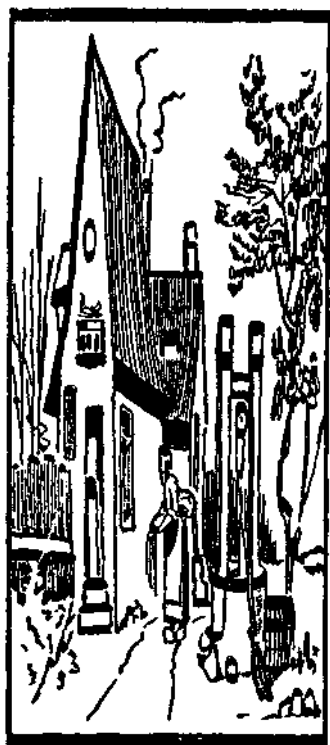
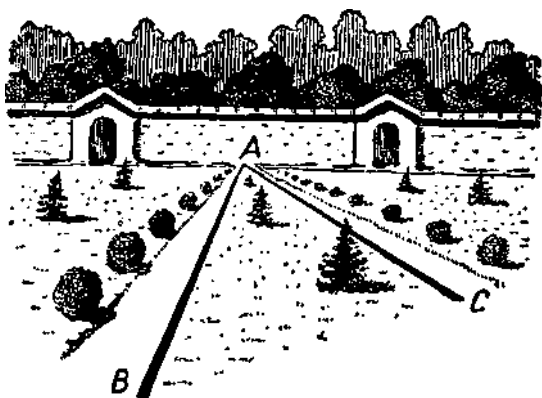

. 150

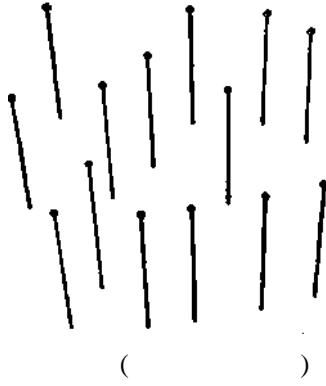

. 151

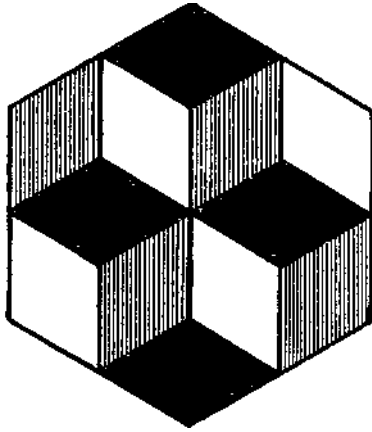

161

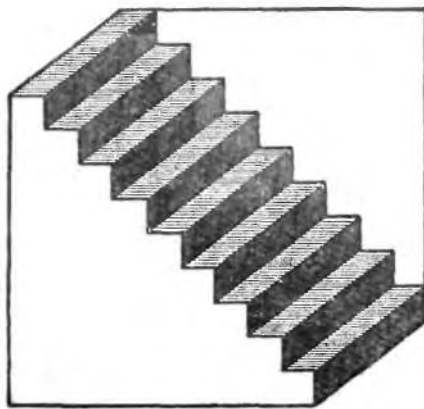

, 2) « » 3) : 1)

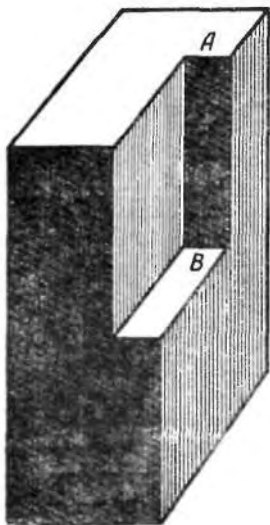

(,
) , (—),

. 154

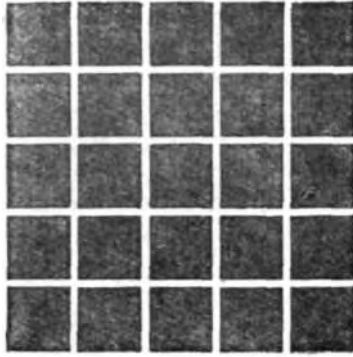

. 155



. 154,

163

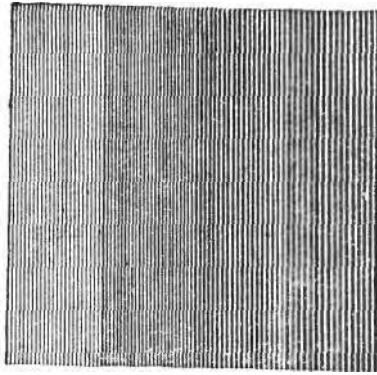

(«),

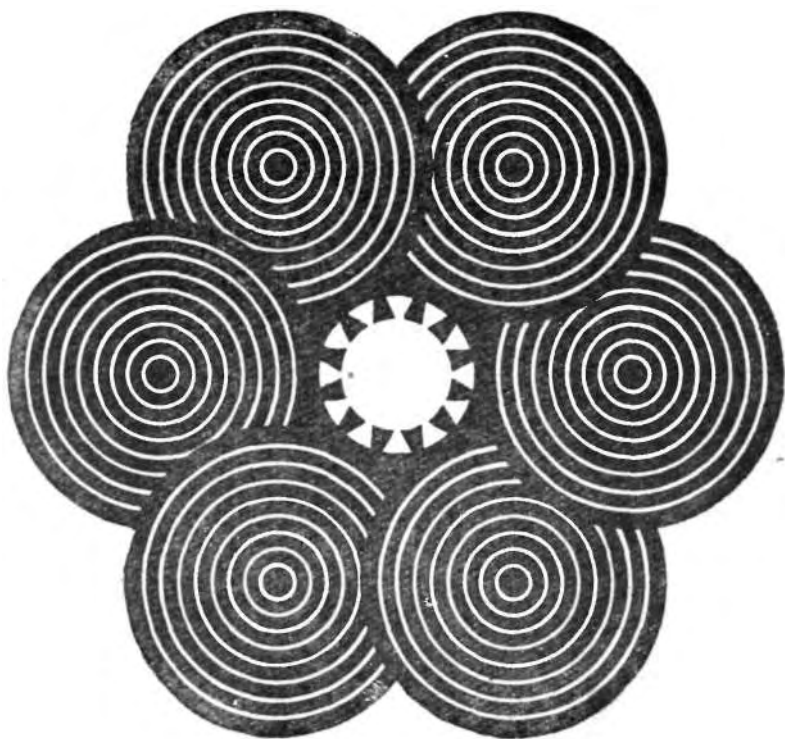

),

(-

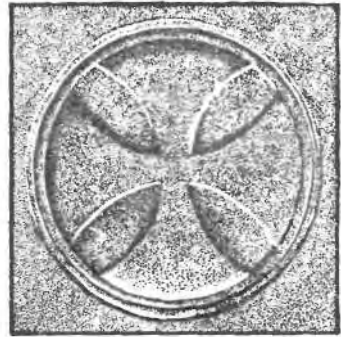
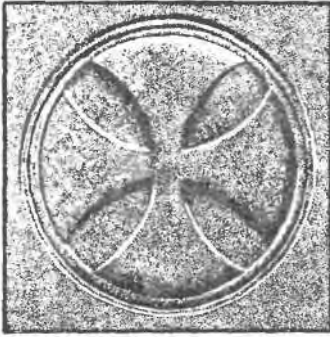

« »

. 161



. 162



167

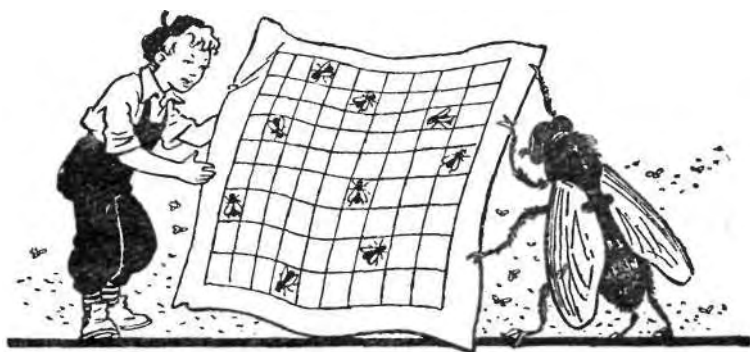

1.

10

24

6 (. 163).



. 163.

»

«

?

164,

1

, 2

, 3

: 10

, 15

, 20

: 1

10

15

20

; 2

; 3

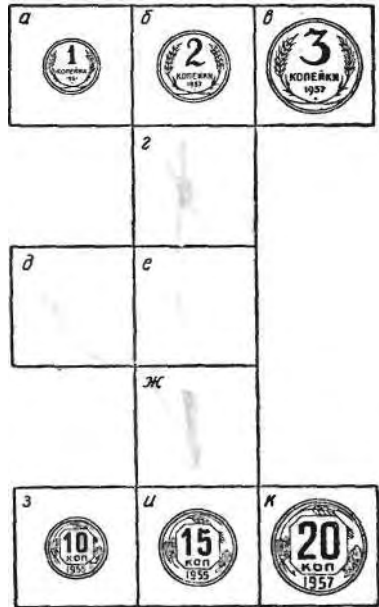

. 164.

?

0 0 0
0 0 0
0 0 0

o	o	o	o	o	o
o	o	o	o	o	o
o	o	o	o	o	o
o	o	o	o	o	o
o	o	o	o	o	o
o	o	o	o	o	o

12

, 36

?

?

(. 165).

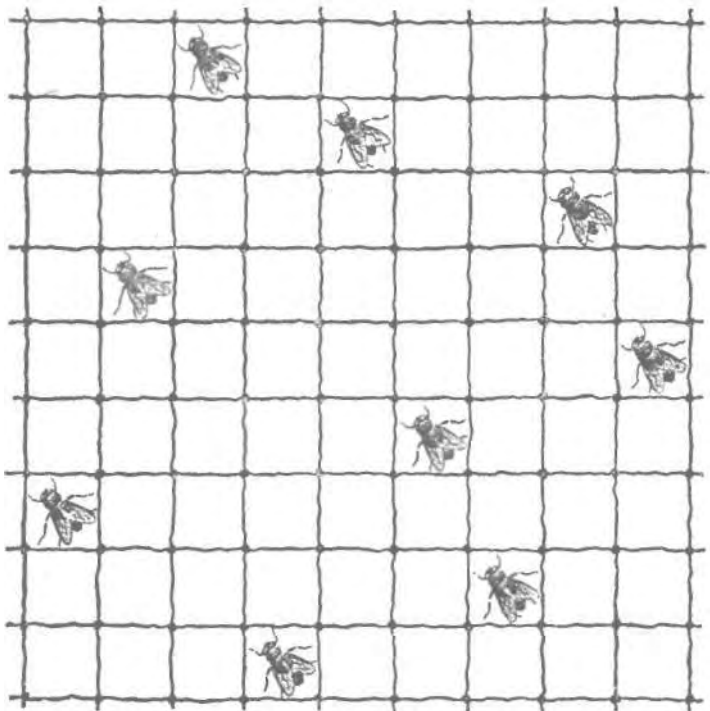

.165.

?

. 166,



. 166.

1 3 . 167 , 6 8— ;

?

173

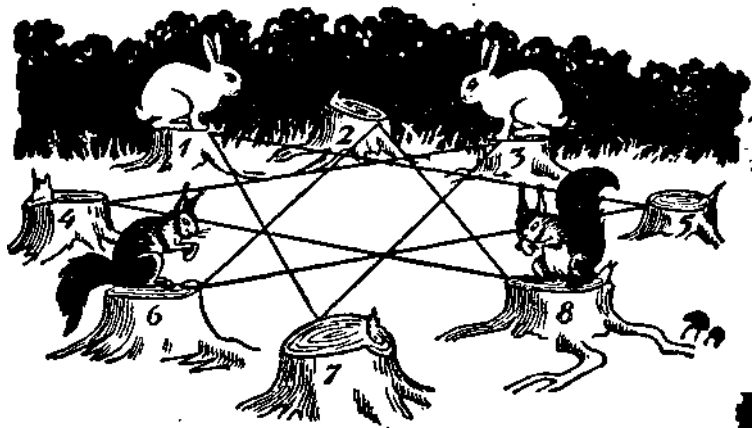

. 167.

1)

2)

16

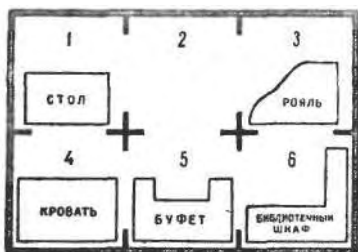

. 168.

174

2.

?

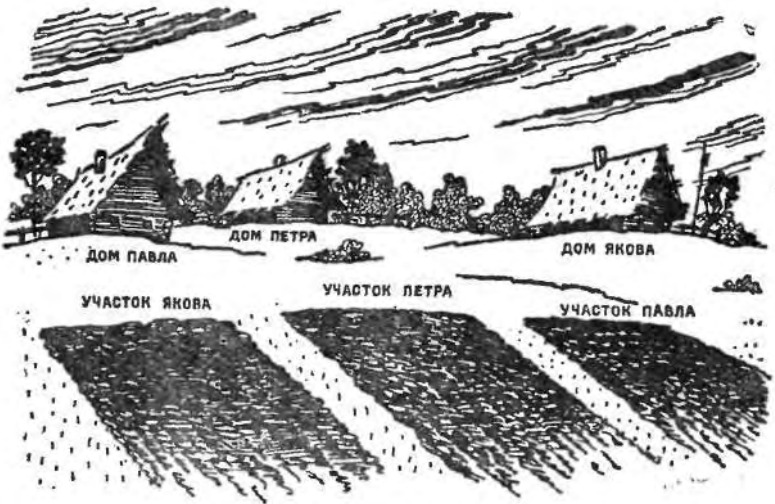

. 169.

(. 170).



. 170.

?

10

. 171.

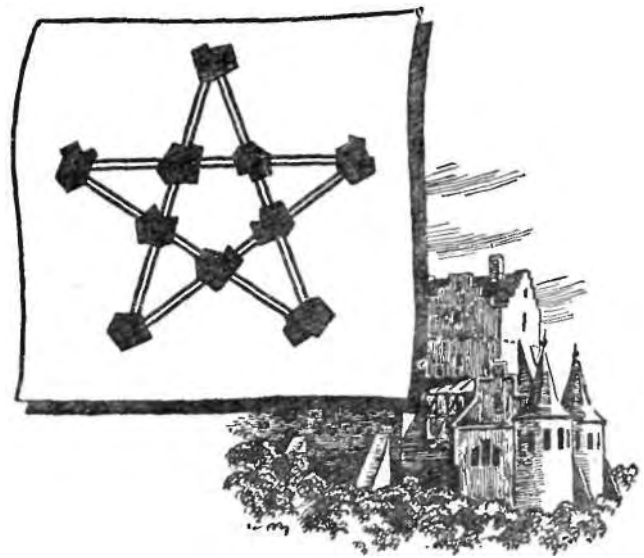

. 171.

10

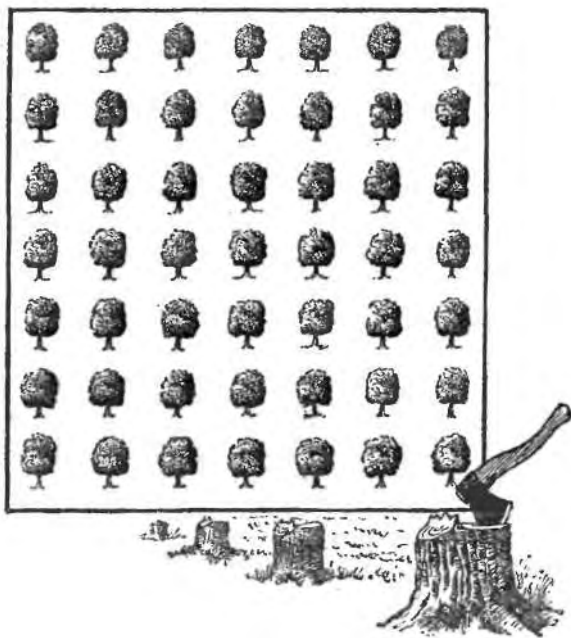

,
 10, 39 : 20
 — , 20 : «20»;
 !—
 10
 29 ? 39.
 ?

13 (. 173),
 : 13



. 173.

?

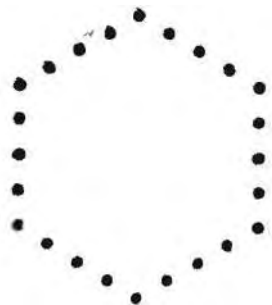

. 174.

. 174.

(. 175).



. 175.

(

):

2—д	15—и	2—г	10—а
15—б	3—ж	1—з	3—д
10—г	20—в	10—д	15—б
2—э	1—д	2—к	2—г
20—д	3—а	15—и	3—к
10—к	15—б	3—ж	2—и

24

. 176.



. 176.

36—12,

36

24,

12,

o		o	o	o	
		o	o	o	o
o	o	o			o
o	o		o		o
o	o			o	o
	o	o	o	o	

64
63

63 64

64

$$64 \times 63 = 4032,$$

. 177

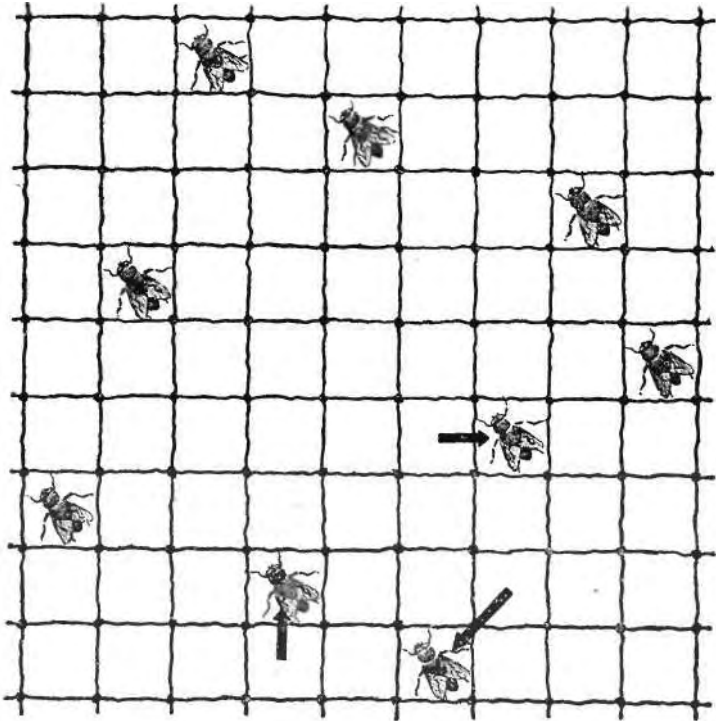

. 177.

16, : (, 1-5)
 1-5; 3-7; 7-1; 5-6; 3-7; 6-2; 8-4; 7-1;
 8-4; 4-3; 6-2; 2-8; 1-5; 5-6; 2-8; 4-3.

17

- | | | | | | |
|----|---|-----|---|-----|---|
| 1. | . | 7. | . | 13. | . |
| 2. | . | 8. | . | 14. | . |
| 3. | . | 9. | . | 15. | . |
| 4. | . | 10. | . | 16. | . |
| 5. | . | 11. | . | 17. | . |
| 6. | . | 12. | . | | . |

. 178.

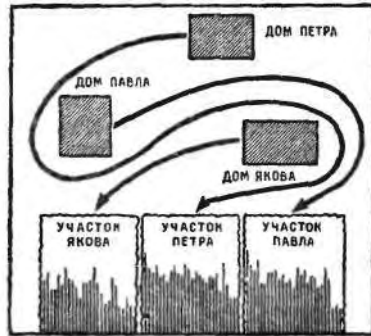

. 178.

179,)
 $24-4=20,$

II

;

$20-18=2,$

I III (

V

(. . 179,).

(. 179,).

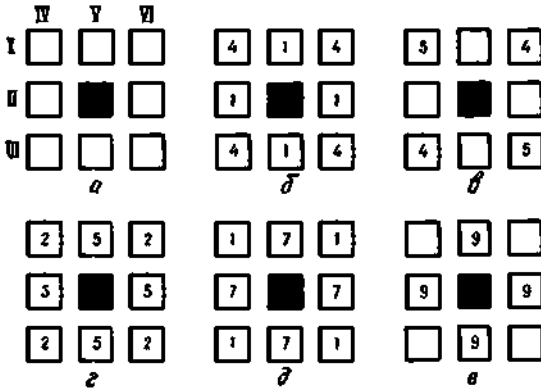

. 179.

(. . 179,).

(. . 179,).

. 179,

12

12

. 180 ()

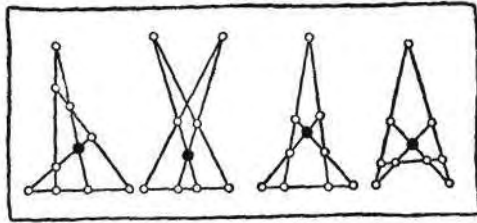

. 180.

. 180 () 10

. 181;

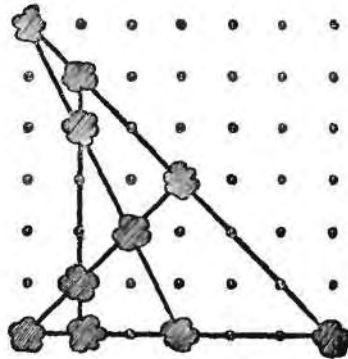
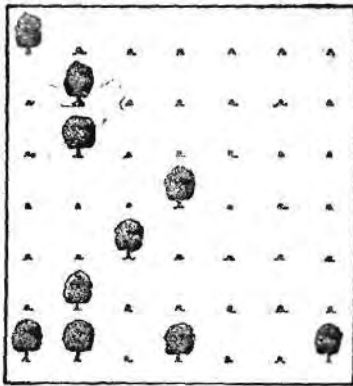

. 181.

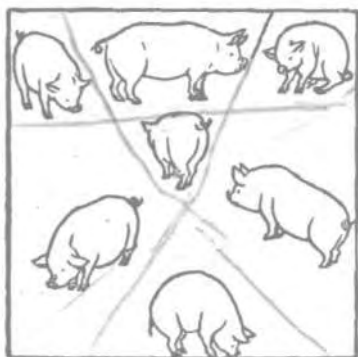

. 182.

. 182

187

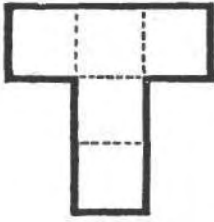

tut. 183.

(. 183)

?

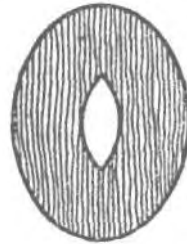
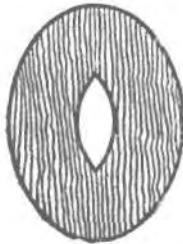

. 184.

. 184 (

(. 185)

, — ,
,
,

,
.
,
.



. 185.



. 186.

(. 186) -

?

(. 187).

—

:
,
-
,
.
-
.
?
,

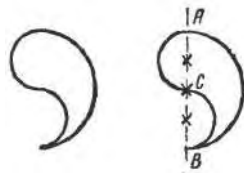

. 187.

(. 188):

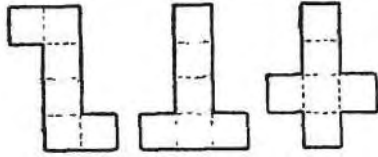
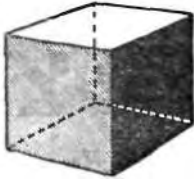

. 188.

10.

(. 189,).

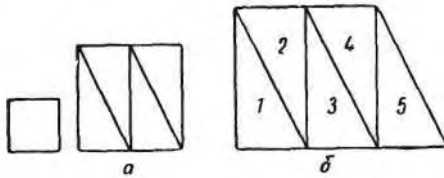

. 189.

(. 189,).

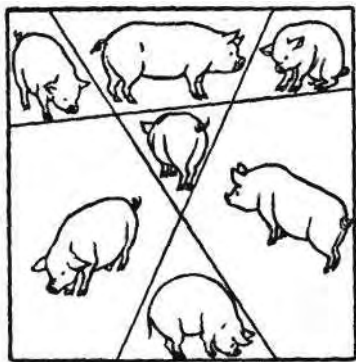

.190.

(.191).

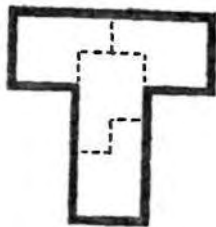

.191.

192,

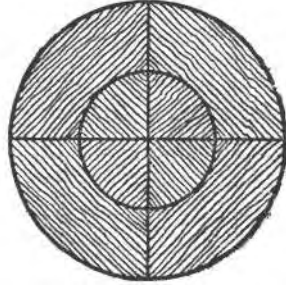
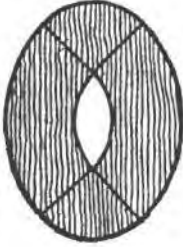

. 192.



. 193.

78,

78:6,

13.

. 193,

192

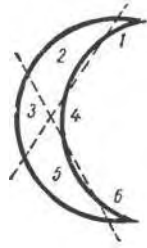

. 194.



(. 195).

. 195.

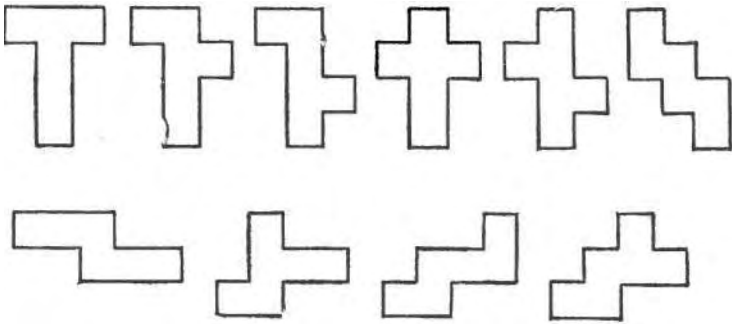

. 196.

1 , 5

(. 196). 10.

; 10, 12,

. 197, .
(. 197,).

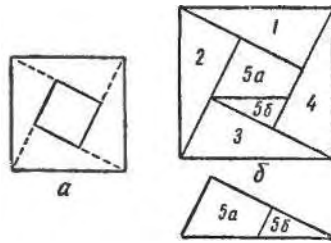

. 197.



(. 198).

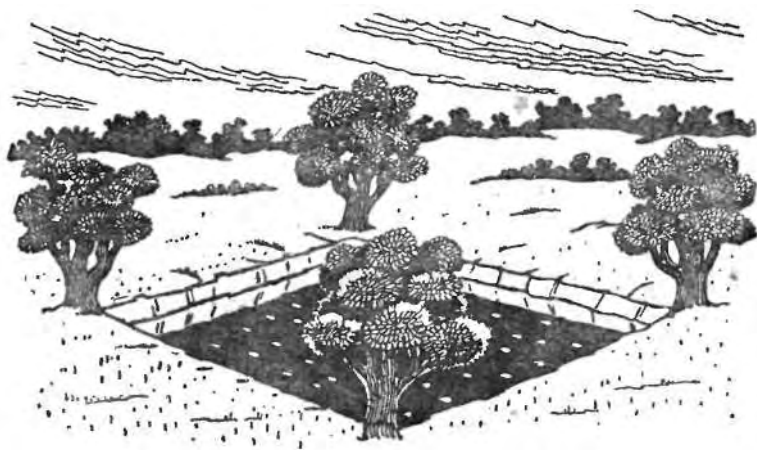

. 198.



. 199.

' , . , ' , .
' ?

, . , . , , -
' , . , . , . , . -
? , . -

. 199, .

' ,
' ,
' ,
' ,

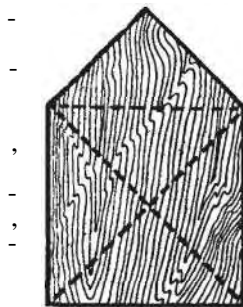

-
-
?
?

. 199, .

' ,
?

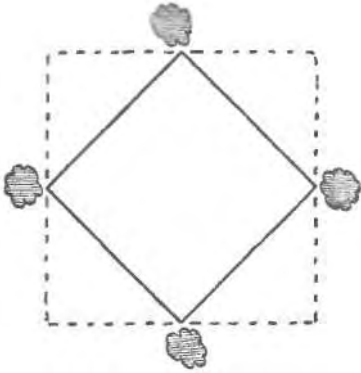

200).

. 200.

. 201

(,).

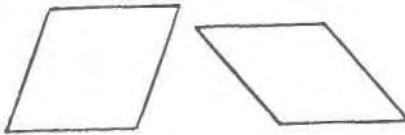

. 201.

. 202.

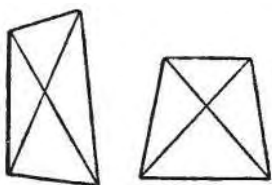

. 202.

. 203.

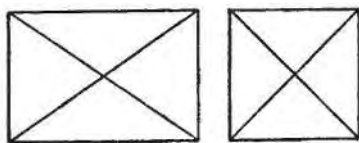

. 203.

. 204

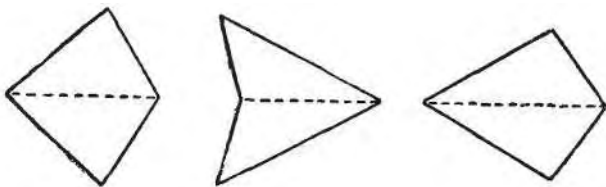

. 204.

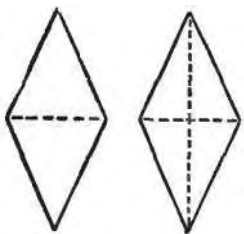

205)

. 205.

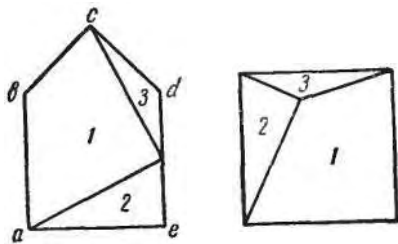

(. 206),

. 206.



100⁵ 100⁵ ? -

1 $\frac{1}{2}$ 5 . -
 ? . .

3 , 20 , -
 . ?



. 207.

—
 ,
 . 207, —
 ,
 ,
 ,
 ?

—
 ?
 100.
 ,
 400 —
 ;
 ?

40 —
 —
 —
 —
 25 —
 —
 —

?

— 3

2

?

:

;

?

50—60

50 100

10

10

110 , 112 , 113 , 114 , 115 ,
116 , 117 , 118 , 120 , 121

?

$$\frac{5}{100} ; \quad \frac{100}{100^5} \quad \frac{5}{100} ; \quad \frac{5}{100} ;$$

$$1\frac{1}{2} \times 5, \quad 7\frac{1}{2} ; \quad 1\frac{1}{2} \times 4 = 6 ;$$

$$; \quad \frac{20^3}{50} ; \quad \frac{20}{50} ; \quad \frac{20}{50} ;$$

$$\begin{array}{r}
 40 \\
 80, \quad 20 \\
 \cdot \\
 -30. \\
 : 10 \times 4 + 30 \times 2 = 100.
 \end{array}$$

$$\begin{array}{r}
 2 \times 25 = 50 \\
 5, \\
 70 + 25 = 95 \\
 : 3 \times 70 + 2 \times 95 = 400.
 \end{array}$$

$$\begin{array}{r}
 (\\
 14, \quad \frac{1}{10} \\
 ; \\
 \frac{1}{10}
 \end{array}$$

$$\begin{array}{r}
 : \\
 ? (\\
 1\frac{1}{2} \\
 205
 \end{array}$$

$1\frac{1}{2}$
 $\frac{2}{5}$
 $\frac{3}{5}$; $\frac{3}{5}$ $2 \times \frac{3}{5} = 1\frac{1}{5}$
 12
 10
 1156
 289
 116 , 117 , 118 , 120 , 121 , 113 , 114 , 115
 1 3 5 1 2
 (121)
 3 5
 1 2
 110 121 $= \frac{231}{(289)}$ 1 2
 3 -58
 112 1 3
 1 112 $-58 = 54$ 3
 2 110 $-54 = 56$ 1 2 54 110

$5 \quad 120 - 58 = 62$. $3 \quad 5, \quad 120, \quad -$
 58 ; ,
 $4 \quad 5 \quad (121 \quad)$. $62 \quad 121, \quad 4,$
 $4 \quad 59$. ,
 $54, \quad 56, \quad 58, \quad 59, \quad 62$.
, .



?

16 . ? ,

140 . , 90 , ,

120 , ? ,

15 , , -

208

, 20 , 20 -
 , . -
 ?
 : 100 -50 :
 - 10 -10 ?
 ?

10% , 10% □
 ? :

. 208
 :
 ?



$\frac{1}{2}$

$\frac{1}{2}$

?

1924

: 1869

— 10
90

30 ».

?

16 , 36
16 36×(. 36) : ,

16/

36×()=16/

36×()×()=16. 16:
36 :

() X () = 16/36

, 4/6=2/3 ,

2/3×12 = 8 .

,

, , 140 -

, 120
— 10 140 — 120 20 , , -

140—10 = 130 .

90 . . . , :
 90 . . . , $130 - 90 = 40$,
 -20 -10 , -
 20 , -110 .

, 20 . ,
 , (100 + 20) .
 , (100 + 20) . ; -

, $3(100y + 20) = 100 + 20$.
 , = 7 .
 = 1, = 7.
 (« = 2; 15 »).
 = 14.
 14 40 ,

21 60 = 3 :
 14 40 , - 14 -
 , $200 + 280 = 480$;
 (1440:3 = 480).
 9 60 $1440 - 480 = 960$, -

	Число	Стоимость
Арбузов	1	50 коп.
Яблок	39	3 руб. 90 коп.
Слив	60	60 коп.
Итого	100	5 руб. 00 коп.

110%,
99%
1%

1,1

$$1,1 \times 0,9 = 0,99,$$

— 16
:

15
, 19

18
31

$$15 + 18 = 33$$

$$16 + 19 + 31 = 66,$$

20

$\frac{1}{2}$

$$7:2 = 3\frac{1}{2}; \quad 3\frac{1}{2} + \frac{1}{2} = 4; \quad 7 - 4 = 3$$

$$3:2 = 1\frac{1}{2}; \quad 1\frac{1}{2} + \frac{1}{2} = 2; \quad 3 - 2 = 1,$$

«

— , , , : — -
 ; , , , , , -
 ? , -
 — , — , — .
 , . , , , ;
 , , , , , ;
 — . ? — -
 — 3 . , . ,
 — , — , — .
 — .
 , , , , , ,
 , 7 , , -
 , , , , , -
 4 1 ; , , : -
 , , , , , ,
 , ; ; .
 , — , — : — ! -
 , , , , , -
 — . ? :
 — 3 :
 — ? ! — .

— : ,— ,— . -
 — . ,
 — 3 ? . ?— .
 — 3 : .
 — .
 6 ; 10 3 . 9 , -
 7 , 10 4 4 -
 10 3 , 7 , -
 10 , , , -
 , , , , -
 , ; —30 -
 , 90 ,— ».

**

, , , -
 , , -
 « (, , — .) -
 , , -
 , ,

· , , -
· , -
· , -
, ' , : « ' » -
, , , -
, » , -
, 20 -
, : « 1 30», « -
», « », « -
, », . . — -
« -
»: ; — —« — -
64 » — -
· , 20 , « -
», (« »). -



89,4 . ,

350 . 500 .
?

30 . ,
?

, 2 , : — — 2 ,
?

?

$\frac{3}{4}$

$\frac{3}{4}$

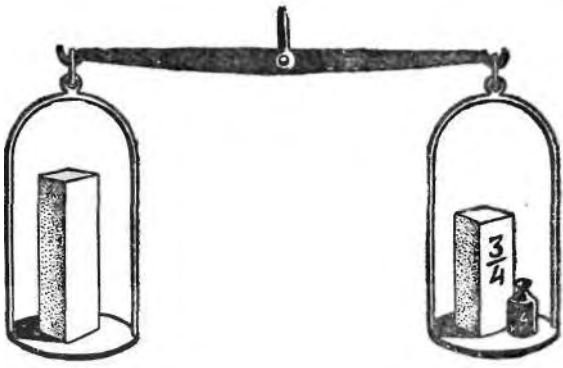

. 209.

?

13 .

15 . 210

218

?
;

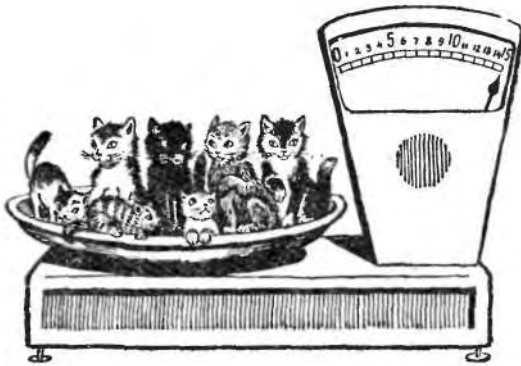
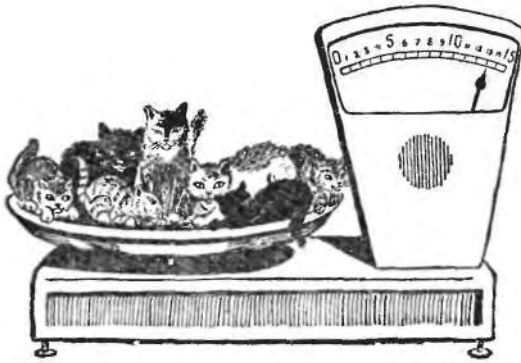

. 210.

. 211

, 12

219

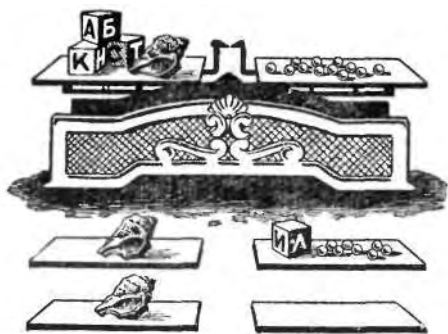

. 211.

?

. 212

10

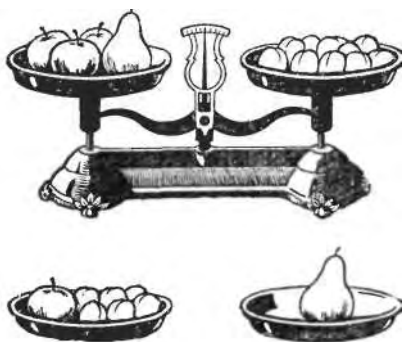

. 212.

?

?

. 213

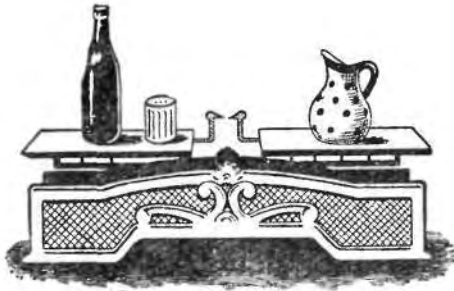

. 213.

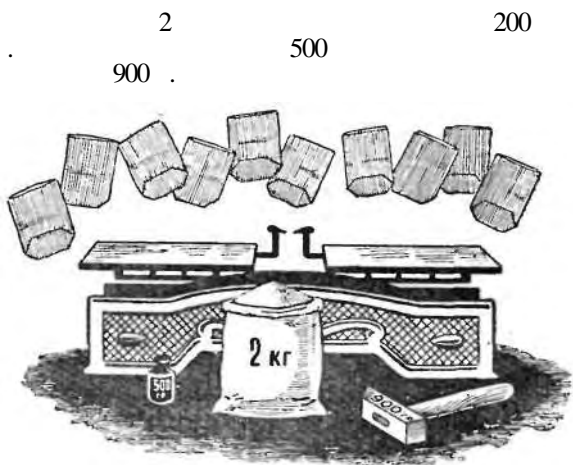

. 214.

? 10

	·	20	,	;
— 10	.		,	-
		8	2	;
10	;	9 ¹ / ₄	,	-
			,	;

$$= 89,4 \cdot 1000 = 89,4 \times 1000 = 89,4 \times 1000 = 89400$$

$$- 89,4$$

$$(500 - 350) \cdot 150 = 150 \cdot 150 = 22500$$

$$300 : (350 - 150) = 200$$

$$: 500 - 200 =$$

$$60$$

« » (,),

) , 2 , 2 -
 (-

8 ()
 $\frac{7}{8}$, $\frac{1}{10}$ — $\frac{7}{8}$, .
 10 . , -

$\frac{3}{4}$, $\frac{1}{4}$, $+\frac{3}{4}$, $\frac{3}{4}$, $+\frac{1}{4}$,
 $\frac{3}{4}$, $\frac{3}{4}$, $\frac{3}{4}$, $\frac{3}{4}$, 3 .

2 . 2 .
 2 .
 : 15 , 2×4 , $4 + 3 = 7$, 8 , ,
 $15 - 8 = 7$.

1 + 2 = 3 . , 1 ,

—
 —8 , 10 , 20 — , -

$$3 + 9 = 12,$$

$$900 - 500 = 400$$

$$2000 - (4 \times 400) =$$

400

400

$$10 - 9\frac{1}{4} = \frac{3}{4}$$

20, 10

$\frac{1}{4}$

1

$$\frac{1}{10} - \frac{1}{20} = \frac{1}{20}$$

$\frac{1}{4}$

$8\frac{1}{5}$

.3

5

$\frac{1}{4}$

$$\frac{1}{4} : \frac{1}{20} = 5$$

2

1 . , I ; .
 ?
 2 ;
 7 ;
 -8 . ?
 ?
 ?
 — 6 ?
 ?
 — 50
 ?
 ?
 ?
 12
 , , ,
 ? ,
 ?



. 215.



. 216.

6 , ?
 6 . -
 , -
 ?

, 6,
 ?



217.

12 , ? ?
 , ?

, , -

, :
12. ,
?

3 .
?
.
.
-
:
-
?
.

IV. : 6, 9, VI,
 100
 () , , ,

720 , 740 . 12 ;
 1 , . ,

20 . 1 , 20 ³ 60 , -
 11 40 . 19 20 ²⁰ . , -

?

3 6 180 . , , 180-50,
 130, , 6 , -
 130. , 26 . ,

$$26 + 50 = 76 ; \quad , \quad 50 \quad , \quad 3 \quad , \quad \frac{6}{180-76} =$$

?

$\frac{1}{12}$; $12 - \frac{1}{12}$; $\frac{1}{12}$; $12 - \frac{1}{12}$; $\frac{11}{12}$; $\frac{1}{12}$; $\frac{11}{12}$; $\frac{1}{12}$; $\frac{11}{12}$; $\frac{1}{11}$; $\frac{11}{12}$; $\frac{11}{12}$; $\frac{5^5}{11}$; 1 ; $\frac{5^5}{11}$; $?$; 1 ; $\frac{5^5}{11}$; 2 ; $10^{10}/11$; 3 ; $\frac{16^4}{11}$; $\frac{1}{12}$; $\frac{5^5}{11}$; $1 \cdot \frac{1}{11} \times 11 = 12$; 11 ; $\frac{16^4}{11}$; 12 ;

1-я встреча	— в 1 час	$\frac{5^5}{11}$ минут
2-я	« — « 2 часа	$\frac{10^{10}}{11}$ «
3-я	« — « 3 «	$\frac{16^4}{11}$ «
4-я	« — « 4 «	$\frac{21^9}{11}$ «
5-я	« — « 5 часов	$\frac{27^3}{11}$ «
6-я	« — « 6 «	$\frac{32^8}{11}$ «

7		—	7	$38^2/_{11}$	«
	8	«	—«8	$43^{1/11}$	«
	9	«	—«9	$49^{1/11}$	«
	10	«	—«10	$54^{6/11}$	«
	11	«	—«12	«	

?

12 , . —

(.), $11/_{12}$

; $1/_{12}$, $1/_{12}$, $6/_{11}$,

$1/_{12}$, $12^{1/_{12}}$, — $32^8/_{11}$, $32^8/_{11}$,

$32^8/_{11}$, $32^8/_{11}$,

?

$32^8/_{11}$, 11 11 12 ; 12 ,

12 . + $32^8/_{11}$. = 12 . $32^8/_{11}$

1 $5^5/_{11}$. + $32^8/_{11}$. = 1 $38^2/_{11}$

2 $10^{10}/_{11}$. + $32^8/_{11}$. = 2 $43^{1/11}$

3 $16^4/_{11}$. + $32^8/_{11}$. = 3 $49^{1/11}$

12 , 12 ,

12 • .

$$1 - 12 \cdot \frac{1}{13} = \frac{1}{13} \quad (1 - 12 \cdot \frac{1}{13} = \frac{1}{13})$$

$$55 \frac{5}{13} \cdot 12 \cdot \frac{12}{13} \cdot \frac{12}{13} \cdot \frac{12}{13} \cdot \frac{12}{13} = 55 \frac{5}{13} \cdot 12^4 \cdot \frac{12^4}{13^4}$$

$$\frac{1 - (12x - 1)}{2} = \frac{1}{13} \quad (1 - (12x - 1) = \frac{2}{13})$$

$$1 \frac{1}{13} = \frac{2}{13} \quad (1 - (12x - 1) = \frac{2}{13})$$

$$2 \frac{10}{13} \cdot 12 \cdot \frac{3}{13} \cdot \frac{11}{6} = 2 \frac{10}{13} \cdot 12 \cdot \frac{3}{13} \cdot \frac{11}{6}$$

?

$$\frac{1}{12} \cdot \frac{1}{2} \cdot 12 \cdot \frac{1}{12} = \frac{1}{12} \cdot \frac{1}{2} \cdot 12 \cdot \frac{1}{12}$$

$$1 - \frac{1}{12} = \frac{11}{12}$$

$$12 - 1 = 11 = 2x \quad (12 - 1 = 11 = 2x)$$

$10x (\dots, 1 = \sqrt[10]{12x - 10x = 2})$.
 10
 $\dot{12}$
 $12^{1/10}$
 $12^{12/10}$
 $12^{1/5}$
 $60/5 = 12$
 12
 12
 $12x - 2 = 2x$
 $10x$
 $12/5 = 2$
 $x = \sqrt[5]{24}$
 10

« 2	« 24	«	7	« 12
« 3	« 36	«	« 8	« 24
« 4	« 48	«	« 9	« 36
« 6	«	«	« 10	« 48
			« 12	«

 $: « 6 » « 12 »$
 $6, \dots, 12$
 12
 $1 = x/2$

$$1^{1/23} = 11^{1/2} \cdot 12 = \dots = 2^{1/23} \cdot 1 \cdot 21^{4/23}, \dots$$

$$\dots \left(\dots^{12/23}, \dots^{2/23}, \dots^{12} \cdot 1^{1/23} \right).$$

$$2 = 11^{1/2} = \dots = 4^{1/23}; \dots - 2 \cdot 5^{5/23} -$$

$$\dots - 3 \cdot 7^{19/23}, \dots$$

: «7».

- 1)
- 2)

$$\dots - 3 \cdot 1^{1/2} \dots$$

9

« 1^{1/2} » (9)

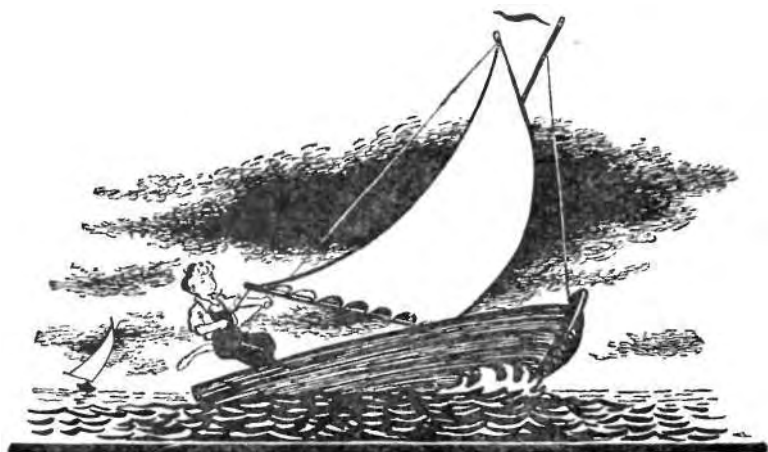

1 20 .
80 . ?

: — , , , — . -
? , ; -
, , , , -
.

: ' , ' ? .

. ? ,

, — 2 15 .
?

?
, , , , .
?

24 ;
— 24 . 16 20 ;
, , , ,
, , , ? .

— 15 . 20 ;
, , , 5 .
?

80 = 1 20 . : , -
 , 1 20 , 80 -
 , , , -
 . : «1 20 »
 «80 », 1 20 80 -
 .

(. 218)

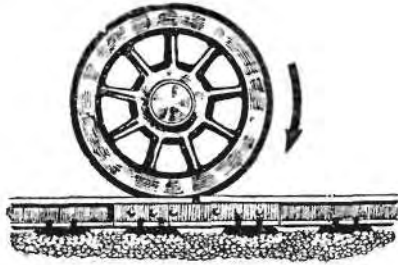

. 218.

$$\begin{array}{r}
 \frac{15}{1000} \\
 \vdots \\
 (\quad) \times 15 \times 60 / 1000 =
 \end{array}
 \begin{array}{l}
 15, \\
 , \\
 .
 \end{array}$$

$$x^2 = 2\frac{1}{4}, \quad x = 1\frac{1}{2}$$

?

, , , -
 , . , ;
 , ; ,
 , — , -
 , , : , -
 , ; , -
 .

, , 24 -
 , 16 -
 , 24 -
 $1\frac{1}{2}$, $\frac{24}{24}$, $\frac{24}{16}$ -
 , .

-1 , 4 1 3 ; -
 , 5 , 300 , -
 , 300 . ,
 , :

$$300/15 \quad 300/20 = 20 \quad 15 = 5.$$

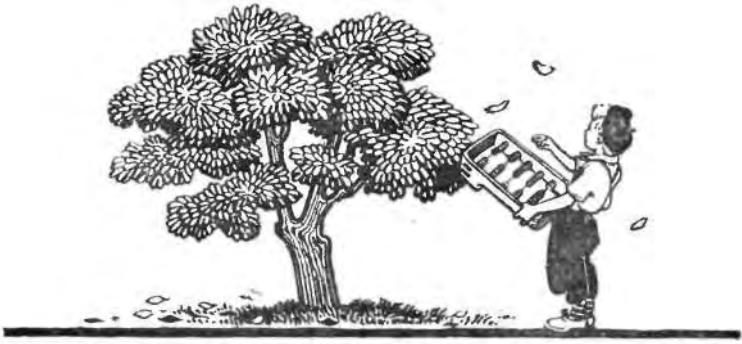

. , , -
 . , , -
 ? , , -

? — . -
 — , , -

(. 219):

6.

1



. 219.

1865),

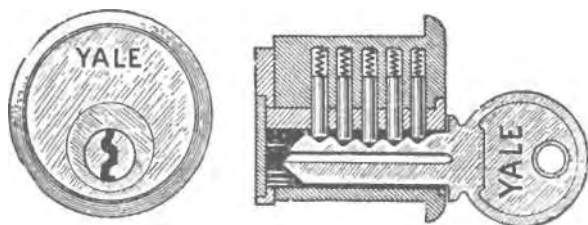

. 220.

— . 220

« ».

«Yale».

(. 220,).

10

?

. 221, —

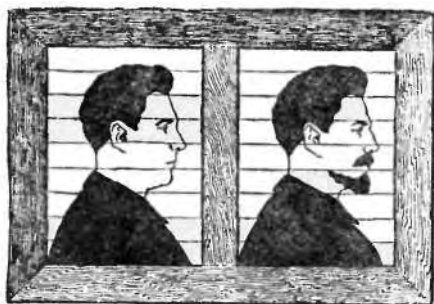

. 221

36

245

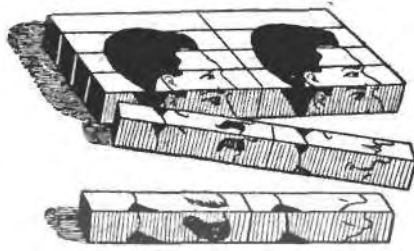

. 222.

(.222), () , 36

?

, , 25 —
 ,
 : , 25 ,
 25 , , 25 .
 , ,

, — , —
 ; , ? —
 , , ?

, , ,

, : 10 , , ? ? -

— , , : -
— (300 ?)!— -
· (5 ?)!— -
?

?
· , -
· ,
?

250

10

$$2 \times 2 \times 2^{1/2} = 8$$

$$8 \times 250 = 2000$$

$$1/2 \times 2000 = 1000$$

$$n, (1000 - n) ?$$

$$6 \times 6 \times 6 \times 6 = 1296$$

125

$$5 \times 5 \times 5 = 125$$

$$125 + 125 + 125 + 125 = 500$$

$$1296 - 500 = 790,$$

$$: 796 \quad 500.$$

$$10 \times 10 \times 10 \times 10 \times 10 = 100\,000.$$

100

100

10

()

?

: I, II, III, IV, V, VI, VII, VIII IX;

1, 2, 3, 4.

I, 1.

II, 1; II, 2; II, 3; II, 4.

(I, 1; I, 2; I, 3; I, 4)

II

I II

4x4 =

= 16

16

III

(III, 1; III, 2; III, 3; III, 4);

16 x 4 = 64

64 x 4 = 256

1, II, III, IV ;

I, II, III, IV, V—1024 ; I, II, III, IV, V,
 VI—4096

$$4 \times 4 \times 4 \times 4 \times 4 \times 4 \times 4 \times 4 \times 4,$$

262 144

1000,
 !

« »

260 000

20

10^{20} ,

: $10 \times 10 \times 10 \times 10 \dots$ (20¹⁰),
 100 000 000 000 000 000 000.

25

25

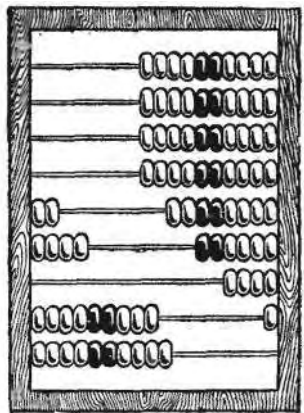

. 223.

250

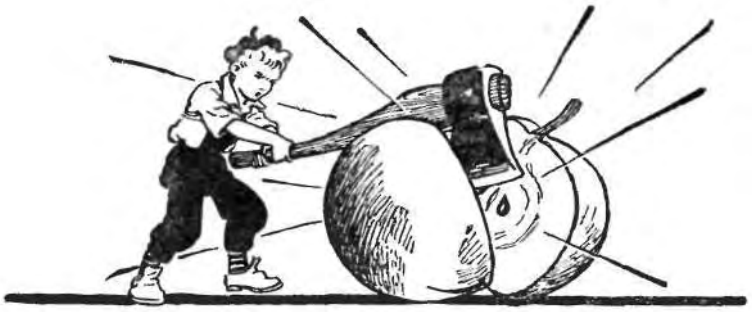

, , , , -
 , , , -
 , , ,
 , , ,
 , , , ?
 , , , .
 : , , ; -
 , , , -
 -
 , , , -
 : , , -
 , , ,
 ;

3500

11

10

. , ,
 .
 — 11 :
 ,
 3 2
 4 « 3 «
 5 « « 4 «
 6 « « 5 «
 7 « « 6 «
 8 « « 7 «
 9 « « 8 «
 10 « « 9 «
 , 10 .
 11 , , -
 , — , -
 , ? .

:
 , , -
 , , -
 . , ,
 . , ,
 . , ,
 , 5 , : -
 4 . , —
 :
 — , , —
 . , —
 — , ?
 — .
 ?

. , ' -
 . ; , -
 , . -
 ? -
 . , -
 1/7 ; — -
 1/7 ; — 1/7 -
 ; — 1/7 -
 , . . ?
 . , -
 — ? — . — -
 — ? ! -
 — , — .

:
 ,
 ,
 ,
 ,
 ?

20

,
 ,
 ?

25

?

?

:
 —300 .
 ,
 ?

200

50

12

12

?

?

?

-
-
-
-
-
-

-
-

?

-

-

?

□
-
-

;

—

.

,

:

—

.

?

,

—

:

,

—

,

—

?

—500

1000

—2000

	4 л	1 1/2 л	2 1/2 л
1-е переливание	1 1/2	—	2 1/2
2-е "	1 1/2	1 1/2	1
3-е "	3	—	1
4-е "	3	1	—
5-е "	1/2	1	2 1/2
6-е "	1/2	1 1/2	2
7-е "	2	—	2

?

2 : 1 11 « »

3 , -

$\frac{1}{5}(1 - x/5)$ $\frac{1}{4}(1 - x/4)$
 $1 - x/5$ $1 - x/4$
 $4(1 - x/5)$ $1 - x/4$
 $4(1 - x/5) = 1 - x/4$
 $3 \cdot \frac{4}{5} = \frac{1}{4}$ $= 3^{3/4}$
1
(2)
3
4
5
6
) (; 1/7

: , , ,
 , , , , ,
 , 6/7
 , , , , ,
 , , , , ,
 , , , , ,
 , 1/7 , ,
 , 6 + 6 = 12
 , 6/7
 , 12:6/7 = 14 ;
 , 4 + 14/7 = 6.

:
 6 + 6 + 6, 18, 6/7 ;
 18 : 6/7 = 21. 3 + 21/7 = 6.
 , , , , ,
 , 12; 18. ? 36. :
 : 24

86400 , 86 400 , 24 -
 12 , 8 -
 , -
 , -

7/21

$$\frac{7}{12} = \frac{3}{12} + \frac{4}{12} = \frac{1}{4} + \frac{1}{3}$$

$\frac{1}{4}$

$\frac{1}{3}$

12

12

$\frac{7}{12}$

100

25

100 —

12

12

100

30

200

20

300

: 50

(500)

1

50

262

200 , $150:5 = 30$ $\frac{60}{60-50} = \frac{60}{10} = 6$ ($\frac{50}{90}$) ,
 $90-50 = 40$ $\frac{300}{50} = 6$. $\frac{60}{90} = \frac{2}{3}$) -
 40 , $\frac{10}{10} = 1$,

$\frac{12}{12} = 1$, -
 — $\frac{12}{12} = 1$ — $\frac{12}{12} = 1$.
 $\frac{12}{12} : \frac{1}{2} + \frac{1}{4} = \frac{3}{4}$,
 $\frac{3}{4}$,

$9:12 = \frac{3}{4}$, $\frac{12}{12}$ -
 $\frac{7}{12} = \frac{3}{12} + \frac{4}{12} = \frac{1}{4} + \frac{1}{3}$. $\frac{7}{12}$.

$\frac{12}{12} = 1$, $\frac{7}{12}$.

?

-
 ;
 ;
 -
 -

. 224.



. 224.

24,

).

).

1 4).

(I IV),

264

6 + 6,

12.

		:	
I 4	II 1	III 2	IV 3
I 3	II 4	III 1	IV 2
I 2	III 1	IV 3	II 4
I 4	III 2	IV 1	II 3
I 3	IV 1	II 4	III 2
I 2	IV 3	II 1	III 4

,

.

,

,

.

,

-

,

-

,

,

,

-

:

-

,

.



« — , — »
« — ».
12 , ,
» , , 12 . «
12 (« — » —). 12 ,
.
.
.
.
.



. 225.

».

«

12 ?

«

».

:

«



1728

».

«

, —

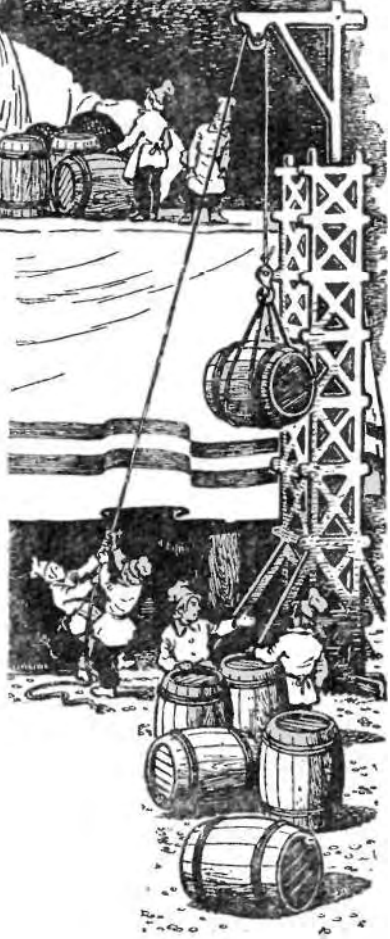

».

?

. 226.

?

?

«

».



18—20 ».
?

38;
— 40 .
?

«

» (. 275)

1728

1728

1728

, 400
400/1728

12

1/4

«

4—5
1½

. 228

».

273



12 , , 12
 12×12
 , 144 (, 150)
 $— 12$
 :

300 , ; , 12 $\frac{1}{3}$ — 1
 1728 , $\frac{1}{3}$
 575 , $\frac{1}{3}$
 300 575
 :
 » (XVIII), 500—600

, , 12
 $12 \times 12 \times 12 = 1728$
 60 ,
 $60/1728$,
 1/30 .
 , 10
 ?

$12 \times 12 \times 12,$

12

12

12

12

1728

1728

1728

300

144

144

$12 \times 12,$

12

144

144

(300)

100

1728

173

(864 !)



. 229.

«

»

$$1\frac{1}{2} \cdot 1\frac{1}{2} \times 12 = 18 \quad ; \quad 12$$

$$18 \times 3\frac{1}{7} = 56$$

).

, 5 ,

$8\frac{1}{2}$!

276

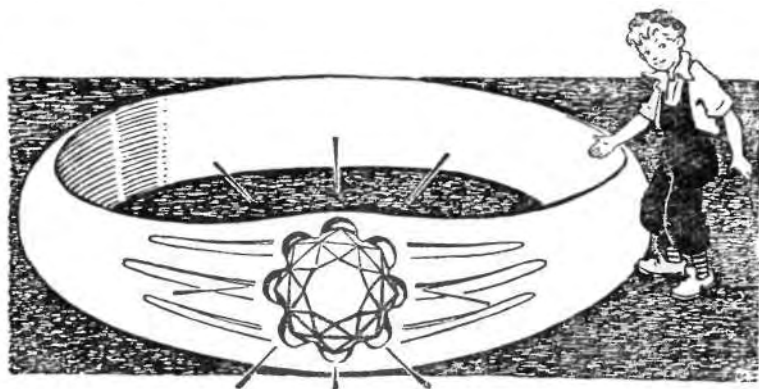

. 230.

(25 12),
 $1\frac{1}{2}$ 3 -
 8-10 .
 XVIII (,) -
 , , « »
 I, 20 -
 30 12 -
 (4) : 360
 4 (2,4) . 240
 ,



. 231.

3 . , 1728 , , -
 500 , , -
 6 , —

12 ,
 40, -
 $40 \times 12 = 480.$ -
 , , -
 « » ,
 « » ,
 « », 1.
 .

1 (— « »).



I

?—

— , ! , -
 , , -
 ...
 — , -
 — , — -
 , — -
 . -
 , -
 — — -
 . -
 . -
 — ?— , , -
 — , -
 . -
 — , : -
 ! , -
 . -
 . -

II

— , !— .
 — , , .
 — : , , -
 5 . ! -
 , -
 . ,
 1 — , .

, 2 , , 4 ;
 — 8 , — 16 ,
 , ,
 , ,
 : , , ,
 , , ,
 — , !— !

III

, 21 , 5 1
 , 8 , , 16 32 , ,
 8^{1/2} (— 84)² 320
 640 , 128 10^{1/2} .
 256 , 13
 12 1^{1/4} . 27
 10^{1/4} .
 , , ,
 1
 2 64 4 × 4 × 4 = 64 .
 ,

2000 12 , -
 13 .
 4096 34 , -
 20^{1/2} .
 14 41 42 ? -
 — ; — , — ,
 — ; — ,
 15 .
 16 384 80 — 53 ,
 164 ; 32 768 67 . -
 ...
 84 328 . -
 65536 18 . -
 131072 -
 655 . -
 — ... , — , -
 — , 262 143 , -
 , 20 -
 .

**

*

1	:	1			5
2	«	2	«	«	10 «
« 3	«	4	«	«	20 «
« 4	«	8	«	«	40 «
« 5	«	16	«	«	80 «
€6	«	32	«	«	160 «
« 7	«	64	«	«	320 «
« 8	«	128	«	«	640 «
« 9	«	256	«	«	1 280 «
10	«	512	«	«	2 « 560 «
« 11	«	1 024	«	«	5 « 120 «
« 12	«	2 048	«	«	10 « 240 «
« 13	«	4 096	«	«	20 « 480 «
« 14	«	8 192	«	«	40 « 960 «
« 15	«	16 384	«	«	81 « 920 «
« 16	«	32 768	«	«	163 « 840 «
« 17	«	65 536	«	«	327 « 680 «
« 18	«	131 072	«	«	655 « 360 «

: , 262 143, — -
 , 5 , -

$$5\,000\,000:262\,143=19$$

64 , () ,

(32 768)

1 32 768,

(32 768 — 1).

65 535.

I

, , -
, -
, -
- -
, -
- -
- -
- -
! -
- -
- -
- -
? -
- 8, - 16,
- 32... ! -
64 , -
! -

II

III

63
64

283,

64 : 2 × 2 × 2 × 2 × 2 × 2 . . . 64

10

1024, — 16.

1024 × 1024 × 1024 × 1024 × 1024 × 1024 × 16.

1024 X 1024, 1 048 576.

1 048 576 × 1 048 576 × 1 048 576 × 16,

: 18 446 744 073 709 551 615.

15

12 000 000 000 000

4 300 000 000 10

!

86400

10

. 1

5 !

163,8

10 ,

100

, , , . -
-
.

(?) 3000 ,

3000

!

3000

3000

3000

$$3000 \times 3000 = 9\,000\,000$$

$$9\,000\,000 \times 3000 = 27\,000\,000\,000.$$

$$27\,000\,000\,000 \times 3000 = 81\,000\,000\,000\,000.$$

$$81\,000\,000\,000\,000 \times 3000 = 243\,000\,000\,000\,000\,000.$$

$$135000\,000\,000\,000 \quad \text{---} \quad \frac{135}{2000} \quad \text{---}$$

2000

!

1 . , ' , -

100 . -

1 : -

1		1	
2	«	100	
3	«	10 000	«
« 4	«	1 000 000	«
« 5	«	100 000 000	«
« 6	«	10 000 000 000	«
« 7	«	1 000 000 000 000	«
« 8	«	100 000 000 000 000	«
« 9	«	10 000 000 000 000 000	«

70 ,

70 ? ,

—

... 1

200 .

XVIII

10

10

, 3 628 800.

10

10

- 1) ;
- 2) « ;
- 3) « .

$$2 \times 3 = 6,$$

:

- 1) ;
- 2) « ;
- 3) « ;
- 4) « .

$$6 = 2 \times 3, \quad 2 = 1 \times 2, \quad 6 \times 4 = 24 ;$$

$$: 1 \times 2 \times 3 \times 4 = 24.$$

$$\times 4 \times 5 = 120. \quad 1 \times 2 \times 3 \times$$

$$: 1 \times 2 \times 3 \times 4 \times 5 \times 6 = \frac{720}{10} . .$$

$$1 \times 2 \times 3 \times 4 \times 5 \times 6 \times 7 \times 8 \times 9 \times 10, \\ \frac{-3\,628\,800}{10}$$

$$, \quad \frac{1 \times 2 \times 3 \times 4}{10} = 24$$

10 ; $10 \times 24 = 240.$
 $\times 5 = 120$? $1 \times 2 \times 3 \times 4 \times 5 = 120$
 120 ; $240 \times 120 = 28\,800.$
 $\frac{79}{100}$ ().
 « 15»¹.
 15
 $1 \times 2 \times 3 \times 4 \times \dots \times 14 \times 15.$
 $: 1\,307\,674\,365\,000,$
 600
 « 15»,
 40
 25 ?
 (—)
 $: 1 \times 2 \times 3 \times 4 \times 5 \times 6 \dots \times 23 \times 24 \times 25.$ 25

. , -
.
, 26 ,— , -
: 15 511 210 043 330 985 984 000 000. -
, — , -
,
« ».



1 7: 1 2 3 4 5 6 7.

40:

$$12 + 34 - 5 + 6 - 7 = 40.$$

40, 55.

: 1 2 3 4 5 6 7 8 9.

100.

100

$$12 + 3 - 4 + 5 + 67 + 8 + 9 = 100.$$

100:

$$123 + 4 - 5 + 67 - 89 = 100.$$

100,

100, 10 . ?

, 10 .

12 321.

: 15, 11,

28?

111. ?

100 :
 $33 \times 3 + 3/3 = 100$

?

10?

37

37,

100 -

12:

$$12 = 3 + 3 + 3 + 3.$$

15 18:

$$15 = (3+3) + (3 \times 3);$$

$$18 = (3 \times 3) + (3 \times 3).$$

5, , ,

, $5 = (3+3)/3 + 3.$

,). 1 10 (1, 2, 3, 4, 5, 6, 7, 8, 9, 10, 5, -

1 10 , . ,

16 , -

?

10 .

8+8+8.

24

:

?

30

: 5×5 + 5.

?

1000

?

?

111
777
999

20.

?

15

1 1 1
3 3 3
5 5 5
7 7 7
9 9 9

1111.

? $4\frac{1}{2}$,
 ?
 , « ' »? \neg
 ?
 , ' $3\frac{1}{2} \times 2$ $2\frac{1}{3} \times 3$, ; 7?
 .

? ' , ,
 , ' ? ' -
 , , , :
 : ? -
 , ' ? ' -

$$\begin{aligned} 2 + 2 &= 4, \\ 2 \times 2 &= 4. \end{aligned}$$

()

?

$$\begin{aligned} &12 \quad 60 \\ &10 \\ : &12 \times 60 = 720, \quad 12 + 60 = 72. \end{aligned}$$

?

?

6729/13458.

, 1/2

: 1/3, 1/4, 1/5, 1/6, 1/7, 1/8, 1/9?

?

$$\begin{array}{r}
 235 \\
 ** \\
 \hline
 **** \\
 **** \\
 \hline
 **56*
 \end{array}$$

?

:

$$\begin{array}{r}
 1 \\
 \times 3*2 \\
 \hline
 3 \\
 + *3*2* \\
 *2*5 \\
 \hline
 1*8*30
 \end{array}$$

?

?

$$\begin{array}{r} \times 15 \\ \hline 25 \\ + 130 \\ \hline 475 \end{array}$$

$$48 \times 159 = 7632.$$

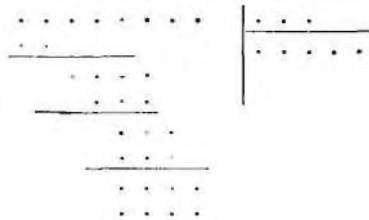

7.

?

:

$$\begin{array}{r}
 *2*5* \quad | \quad 325 \\
 *** \quad | \quad 1** \\
 \hline
 *0** \\
 *9** \\
 \hline
 5 \\
 5 \\
 \hline
 \end{array}$$

11

11.

() ,

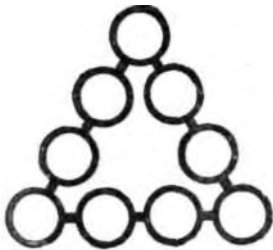

. 232.

(. 232)

20.

(. 233) ,

17.

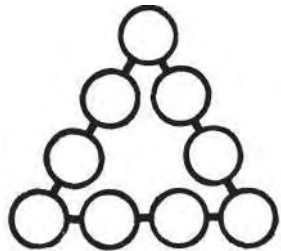

. 233.

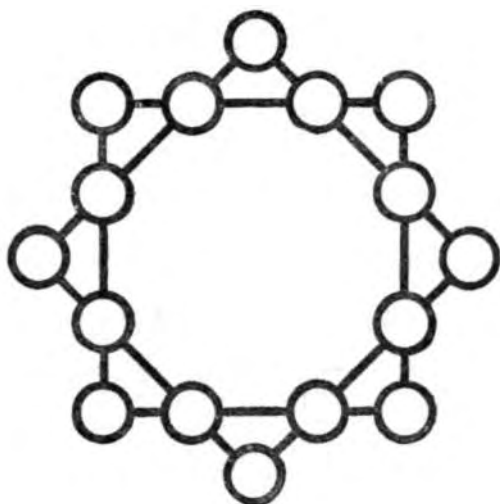

. 234.

1 16

234, ,

34

34.

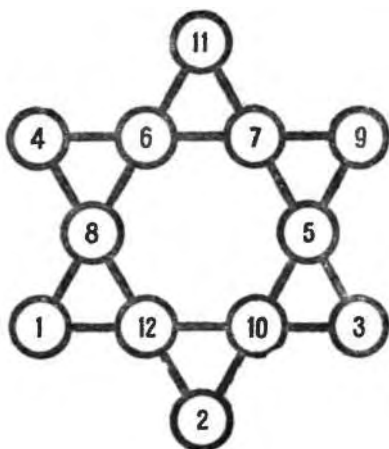

. 235.

.235,

« » :

,

$$1 + 6 + 8 + 1 = 26,$$

$$4 + 6 + 7 + 9 = 26,$$

$$1 + 7 + 5 + 3 = 26,$$

$$4 + 8 + 12 + 2 = 26,$$

$$1 + 12 + 10 + 3 = 26.$$

$$9 + 5 + 10 + 2 = 26,$$

:

$$4 + 11 + 9 + 3 + 2 + 1 = 30.$$

(26),

?

(26)

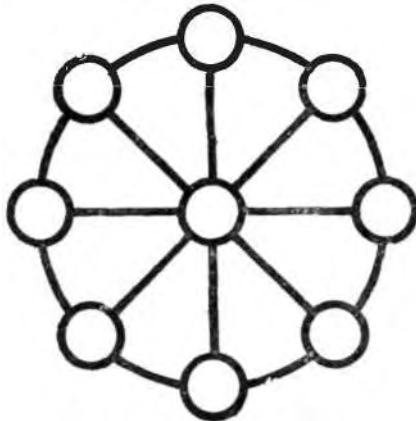

.236

1 9

.236

15,

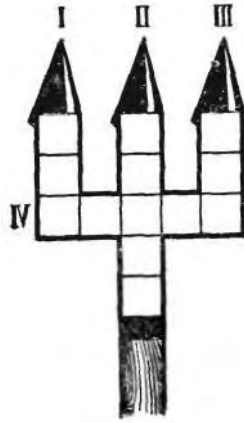

. 237.

(. 237)

(IV) 1 13
 (I, II, III)
 .
 .

$$123 + 4 - 5 - 67 = 55;$$

$$1 - 2 - 3 - 4 + 56 + 7 = 55;$$

$$12 - 3 + 45 - 6 + 7 = 55.$$

100

$$123 - 45 - 67 + 89 = 100.$$

100.

$$70 + 24\frac{9}{18} + 5\frac{3}{6} = 100;$$

$$80\frac{27}{54} + 19\frac{3}{6} = 100;$$

$$87 + 9\frac{4}{5} + 3\frac{12}{60} = 100;$$

$$50\frac{1}{2} + 49\frac{38}{76} = 100.$$

$$148/296+35/70=1.$$

$$123\ 456\ 789^0; 234\ 567^{9\ 8\ 1} \dots$$

15

$$(2 + 2)^2 - \frac{2}{2} = 15; \quad \frac{22}{2} + 2 \times 2 = 15;$$

$$(2 \times 2)^2 - \frac{2}{2} = 15; \quad \frac{22}{2} + 2^2 = 15;$$

$$2^{(2+2)} - \frac{2}{2} = 15; \quad \frac{22}{2} + 2 + 2 = 15.$$

Число 11:

$$\frac{22}{2} + 2 - 2 = 11.$$

12 321.

$$(222/2)^2=111^2=111 \times 111=12321.$$

$$22 + 2 + 2 + 2 = 28.$$

$$222/2=111$$

$$33/3\ 3/3=10.$$

10

$$\frac{11}{1} - \frac{1}{1} = \frac{22}{2} - \frac{2}{2} = \frac{44}{4} - \frac{4}{4} = \frac{99}{9} - \frac{9}{9},$$

$$\frac{3 \times 3 \times 3 + 3}{3} = 10,$$

$$\frac{3^3}{3} + \frac{3}{3} = 10.$$

37

$$33 + 3 + \frac{3}{3} = 37;$$

$$\frac{333}{3 \times 3} = 37.$$

100

$$111 - 11 = 100;$$

$$33 \times 3 + \frac{3}{3} = 100;$$

$$5 \times 5 \times 5 - 5 \times 5 = 100;$$

$$(5 + 5 + 5 + 5) \times 5 = 100.$$

$$1 = 33/33 (\quad);$$

$$2 = \frac{3}{3} + \frac{3}{3};$$

$$3 = \frac{3 + 3 + 3}{3};$$

$$4 = \frac{3 \times 3 + 3}{3};$$

$$6 = (3 + 3) \times \frac{3}{3}.$$

$$1 = \frac{44}{44}, \text{ или } \frac{4+4}{4+4}, \text{ или } \frac{4 \times 4}{4 \times 4} \text{ и т. д.}$$

$$2 = \frac{4}{4} + \frac{4}{4}, \text{ или } \frac{4 \times 4}{4 + 4};$$

$$3 = \frac{4 + 4 + 4}{4}, \text{ или } \frac{4 \times 4 - 4}{4};$$

$$4 = 4 + 4 \times (4 - 4);$$

$$5 = \frac{4 \times 4 + 4}{4};$$

$$6 = \frac{4 + 4}{4} + 4;$$

$$7 = 4 + 4 - \frac{4}{4}, \text{ или } \frac{44}{4} - 4;$$

$$8 = 4 + 4 + 4 - 4, \text{ или } 4 \times 4 - 4 - 4;$$

$$9 = 4 + 4 + \frac{4}{4};$$

$$10 = \frac{44 - 4}{4}.$$

;

$$\frac{55}{5} + 5 = 16.$$

:

$$9 + \frac{99}{99} = 10,$$

$$\frac{99}{9} - \frac{9}{9} = 10.$$

, :

$$\left(9 \frac{9}{9}\right)^{\frac{9}{9}} = 10,$$

$$9 + 99^{9-9} = 10.$$

:

$$22 + 2 = 24;$$

$$3^3 - 3 = 24.$$

:

$$6 \times 6 - 6 = 30;$$

$$3^3 + 3 = 30;$$

$$33 - 3 = 30.$$

$$888 + 88 + 8 + 8 + 8 = 1000.$$

?

):

(
011
000
009

$$, 11 + 9 = 20.$$

100	111	011	101
000	030	330	303
005	000	000	000
007	070	770	707
999	900	000	000
1111	1111	1111	1111

1, 0 8. , , , —
 XIX , , , 18.
 1818 8181 : 1818 .
 1818: $4\frac{1}{2}$,
 $1818 \times 4\frac{1}{2} = 8181$.

?
 XX : 1961 .
 ?

: 1 7. .

:

$3 \times 1 = 3$;	$3 + 1 = 4$;
$10 \times 1 = 10$;	$10 + 1 = 11$;

2 2.

— 2. -

1, 2 3

1
:

$$1 + 2 + 3 = 6;$$

$$1 \times 2 \times 3 = 6.$$

:

$$3 + 1\frac{1}{2} = 4\frac{1}{2},$$

$$3 \times 1\frac{1}{2} = 4\frac{1}{2},$$

$$5 + 1\frac{1}{4} = 6\frac{1}{4},$$

$$5 \times 1\frac{1}{4} = 6\frac{1}{4},$$

$$9 + 1\frac{1}{8} = 10\frac{1}{8},$$

$$9 \times 1\frac{1}{8} = 10\frac{1}{8},$$

$$11 + 1,1 = 12,1,$$

$$11 \times 1,1 = 12,1,$$

$$21 + 1\frac{1}{20} = 22\frac{1}{20},$$

$$21 \times 1\frac{1}{20} = 22\frac{1}{20},$$

$$101 + 1,01 = 102,01,$$

$$101 \times 1,01 = 102,01,$$

:

$$2 : 1 = 2,$$

$$2 \times 1 = 2,$$

$$7 : 1 = 7,$$

$$7 \times 1 = 7,$$

$$43 : 1 = 43,$$

$$43 \times 1 = 43.$$

— 81:

$$\frac{81}{8+1} = 8 + 1.$$

11 ; 14 35; 15 30; 20 20.

$$\begin{array}{ll}
 11 \times 110 = 1210; & 11 + 110 = 121; \\
 14 \times 35 = 490; & 14 + 35 = 49; \\
 15 \times 30 = 450; & 15 + 30 = 45; \\
 20 \times 20 = 400; & 20 + 20 = 40.
 \end{array}$$

10,

$$\frac{1}{1}, \frac{2}{2}, \frac{3}{3}, \frac{4}{4} \text{ и т. д. до } \frac{9}{9}.$$

$1^0, 2^0, 3^0, 4^0 \dots 9^0,$

$$\frac{1111}{250} : 11^{11}.$$

285

0/0 0^0;

$$\begin{aligned} \frac{1}{3} &= \frac{5823}{17469} ; \frac{1}{4} = \frac{3942}{15768} ; \\ \frac{1}{5} &= \frac{2697}{13485} ; \frac{1}{6} = \frac{2943}{17658} ; \\ \frac{1}{7} &= \frac{2394}{16758} ; \frac{1}{8} = \frac{3187}{25496} ; \\ &\frac{1}{9} = \frac{6381}{57429} . \end{aligned}$$

5.

6?

1.

$$\begin{array}{r} 235 \\ \hline ** \\ **1* \\ ***5 \\ \hline **56* \end{array}$$

).

$$\begin{array}{r} 5 (\\ 6 - \\ 235 \\ *6 \\ \hline 1410 \\ ***5 \\ \hline **560 \end{array}$$

96.

$$\begin{array}{r}
 \times *1* \\
 \hline
 *3*2 \\
 + *3* \\
 \hline
 + 3*2* \\
 \hline
 *2*5 \\
 \hline
 1*8*30
 \end{array}
 \begin{array}{l}
 \text{I} \\
 \text{II} \\
 \text{III} \\
 \text{IV} \\
 \text{V} \\
 \text{VI}
 \end{array}$$

0: , 0 III
VI
 : , , I
 5 (V) , 3² ,
 II : 8, 20 (IV) 8
 I: 4, 3 (4, IV) 8,
 :
 ,

$$\begin{array}{r}
 \times 415 \\
 \hline
 382 \\
 \hline
 830 \\
 + 3320 \\
 \hline
 1245 \\
 \hline
 158530
 \end{array}$$

?

$$\begin{array}{r}
 \times 325 \\
 \times 147 \\
 \hline
 2275 \\
 + 1300 \\
 + 325 \\
 \hline
 47775
 \end{array}$$

- 12×483=5796,
- 42×138=5796,
- 18×297=5346,
- 27×198=5346,
- 39×186=7254,
- 48×159=7632,
- 28×157=4396,
- 4×1738=6952,
- 4×1963=7852.

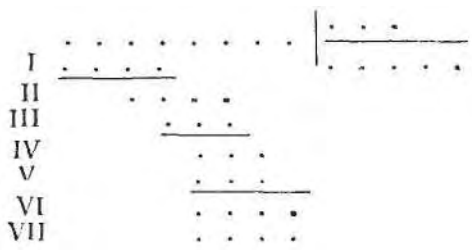

0, II , , IV V
 , 7 (, 100 , 7
 999, , 100, 7

999—100, 899, 900, 128.

900: 128, 7,03, 8, 9.

I VII

8, —9.

() : 90 879.

11

7

10 360 206 : 114	} = 90 879.
10 451 085 : 115	
10 541 964 : 116	
10 632 843 : 117	
10 723 722 : 118	
10 814 601 : 119	
10 905 480 : 120	
10 996 359 : 121	
11 087 238 : 122	
11 178 117 : 123	
11 268 996 : 124	

?

— 52650	325
— 325	— 162
— 2015	
— 1950	
— 650	
— 650	

II

11.

11,

11
 23 658 904.
 3 + 5 + 9 + 4 = 21;
 2 + 6 + 8 + 0 = 16.
 () :
 21 - 16 = 5.
 (5) 11;
 11.
 — 7 344 535:
 3 + 4 + 3 = 10;
 7 + 4 + 5 + 5 = 21;
 21 - 10 = 11.
 11 11, 11.
 11
 : 352 049 786.
 3 + 2 + 4 + 7 + 6 = 22,
 5 + 0 + 9 + 8 = 22.
 22 - 22 = 0;
 11. : 987 652 413.
 : 102 347 586.

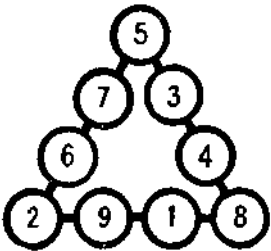

. 238.

. 239.

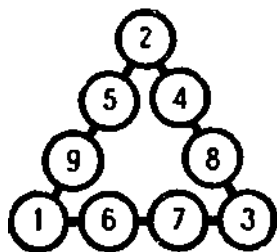

. 239.

. 240.

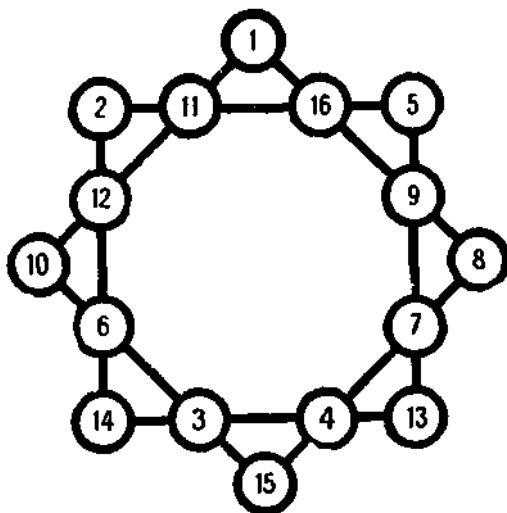

. 240.

, 26;
 $\frac{68}{78-26=52}$,
 — $26 \times 3 = 78$, 26;
 , ()
 , 52, -
 13. $78 - 52 = 26$;
 12, 11 (?)
 , 10, -
 , : 1 2. -
 . 241.

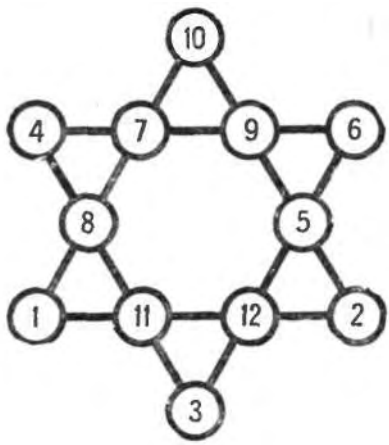

. 241.

. 242.

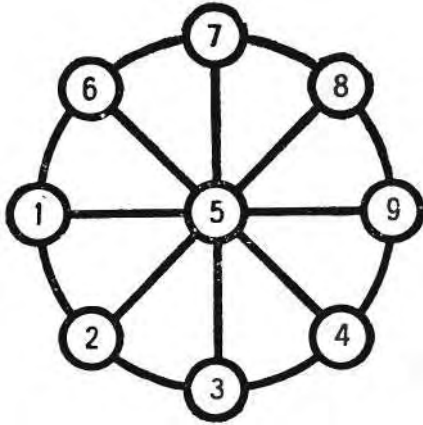

. 242.

(. 243).
25.

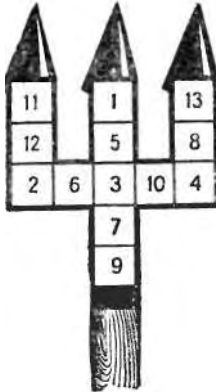

. 243.



9,

— 10

4 9.

— ; : 36; , $4 \times 9 = 36$.

: $7 \times 9?$

— : 63.

$9 \times 9?$

, — : 81.

6×9 , , , 54 56.

$6 \times 9 = 54$.

()

,
.
,
.
,
.
?
?

, . ?
?

? .

. ' ?

— — : . ' :
? , .

— , , ?
— ? ,
— ?
— 100 , -
.

?
,
, : . ?
?

?
?
:
— —

?
,
, , ,
, , ,
, , ,

— : , , !
 — 21 , — : — —
 , . ?

— : ,
 ? , ,
 — , .
 — , ? , .
 — . ?
 ?

15 . —
 , , 4 . 5 ; —
 ?

— 15 , . —
 — , . —
 ?

, 24 . : 8
 2 50 -
 4 , 30 .
 — , ?

— ,
 , — .
 — , — .
 ? ,

2 . , 2 50 .
 ? .

60 . 68 .
 ?

, , , , ,
 : , ? ,
 , , ,

, — ; . — — ; — — ?
— , — : —
,
!
.

, 10 1 5 — 100 : 50 —
?

?
4 65 ,
42.
?

, — 10 10 — —
() , ?

” ”
, ,
“ »

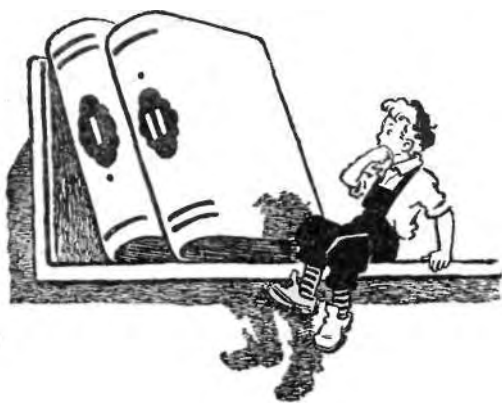

. 244.

800

« »?

54

?

?

328

?

,

,

,

,

-

.

1 + 2,

35

60.

$$: 5 + 35 + 60 = 100.$$

10

15

$1\frac{1}{2}$

$\frac{15}{40}$, $\frac{45}{10}$,
 ?

$$3(x+3) - 3(x-3) = 18$$

$$3 \times 21 - 3 \times 15 = 63 - 45 = 18$$

$$\frac{-21}{4} = -\frac{21}{4}$$

12 : 21 4 16

$5^{1/4}$, $21^{21/12} = 1^{3/4}$, $10^{1/2}$, $3^{1/2}$

. ,) . (, — — -

?

, () : -
 ?

;
 ;
 ;

A

15 ».) (10 , 1 ; 5 , 10 : «

1/15

$$\frac{24}{8}$$

$$\frac{8}{24}$$

$$\frac{-4}{-2}$$

$$\frac{30}{50}$$

$$24$$

$$72$$

$$-8$$

$$30$$

$$\frac{72}{8}$$

$$8,$$

$$64$$

$$4$$

$$30$$

$$64:4=16$$

6

$$8-1=7,$$

$$4+1=5.$$

$$7-1=6; 5+1=6.$$

50

$$1$$

$$2$$

$$\frac{50}{25}$$

$$\frac{2}{2}$$

$$25$$

$$68 - 4 = 64$$

$$60 \quad 52 \quad 4 \quad 60$$

8

21

$$7 + 3\frac{1}{2}$$

$$10\frac{1}{2}$$

$$3\frac{1}{2}$$

1-й кооператив	{ 3 полных 1 полуполную 3 пустых }	Итого меду 3 $\frac{1}{2}$ бочки
2-й кооператив	{ 2 полных 3 полуполных 2 пустых }	Итого меду 3 $\frac{1}{2}$ бочки
3-й кооператив	{ 2 полных 3 полуполных 2 пустых }	Итого меду 3 $\frac{1}{2}$ бочки

По другому способу кооперативы получают:

1-й кооператив	{ 3 полных 1 полуполную 3 пустых }	Итого меду 3 $\frac{1}{2}$ бочки
2-й кооператив	{ 3 полных 1 полуполную 3 пустых }	Итого меду 3 $\frac{1}{2}$ бочки
3-й кооператив	{ 1 полную 5 полуполных 1 пустую }	Итого меду 3 $\frac{1}{2}$ бочки

, 10²⁰ , 20, (10 -
). " " -
 , « » 800 + 800 -
 : . 328. , -
 , , -
 « » , , -
 , , -
 : , — . -
 , , -
 6 × 8 = 48, , -
 , , -
 , 54. -
 , , -
 30 , 24 , -
 30 + 24 = 54, : -
 , 8 × 8 = 64, 10 , -
 , , -
 54. , -
 . , -

2, 3, 4, 5, 6, 7. -
 420. -
 420 . ' -

) (, -
 8 × 7 = 56 . : , , -
 (,) . ,
 56 / 2 = 28 .

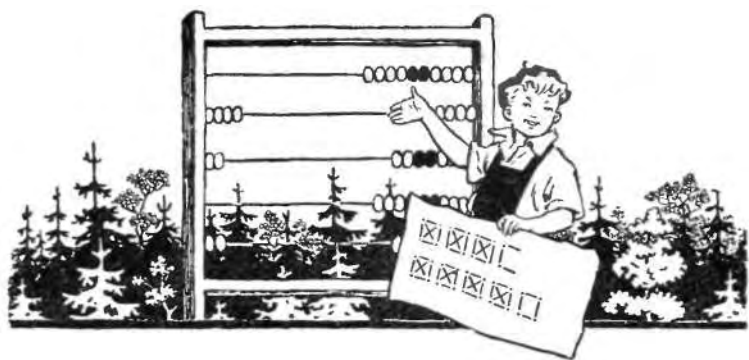

?

?

?

« », « », « »

?

?

!

Гвоздей	Винтов



. 245.

. 245.

11

10



. 246.

. 246.

$$30 + 5 + 3 = 38.$$



. 247.

10 (. 247).

Сосен	
Елей	
Берез	
Осин	

. 248.

СОСЕН	☑ ☑ ☑ ☑ ☑ ☐
	☑ ☑ ☑ ☑ ☑
ЕЛЕЙ	☑ ☑ ☑ ☑ ☑ ☑ ☑ ☑
	☑ ☑ ☑ ☑ ☑ ☑ ☑ ☐
БЕРЕЗ	☑ ☑ ☑ ☑ ☑
	☑ ☑ ☑ ☑
ОСИН	☑ ☑ ☑ ☑
	☑ ☑ ☑ ☐

. 248.



()

§ 1.
 (, 27×8),
 ,
 ($7 \times 8 = 56$) , ($20 \times 8 = 160$),
 = 216). ($160 + 56 =$

:
 $34 \times 7 = 30 \times 7 + 4 \times 7 = 210 + 28 = 238,$
 $47 \times 6 = 40 \times 6 + 7 \times 6 = 240 + 42 = 282.$

§ 2.
19X9:

	2	3	4	5	6	7	8	9
11	22	33	44	55	63	77	88	99
12	24	36	48	60	72	84	96	108
13	26	39	52	65	78	91	104	117
14	28	42	56	70	84	98	112	126
15	30	45	60	75	90	105	120	135
16	32	48	64	80	96	112	128	144
17	34	51	68	85	102	119	136	153
18	36	54	72	90	108	126	144	162
19	38	57	76	95	114	133	152	171

$147 \times 8 = 140 \times 8 + 7 \times 8 = 1120 + 56 = 1176.$

§ 3.

$225 \times 6 = 225 \times 2 \times 3 = 450 \times 3 = 1350.$

§ 4.

§ 1.

:

$$6 \times 28 = 28 \times 6 = 120 + 48 = 168.$$

§ 5.

$$29 \times 12 = 29 \times 10 + 29 \times 2 = 290 + 58 = 348.$$

$$41 \times 16 = 41 \times 10 + 41 \times 6 = 410 + 246 = 656.$$

$$(41 \times 16 = 16 \times 41 = 16 \times 40 + 16 = 640 + 16 = 656).$$

§ 6.

$$(14 = 2 \times 7),$$

$$(\text{§ 3}).$$

$$45 \times 14 = 90 \times 7 = 630.$$

4 8

§ 7.

$$112 \times 4 = 224 \times 2 = 448.$$

$$335 \times 4 = 670 \times 2 = 1340.$$

§ 8.

$$217 \times 8 = 434 \times 4 = 868 \times 2 = 1736.$$

$$(10 - 2):$$

$$217 \times 8 = 2170 - 434 = 1736.$$

$$217 \times 8 = 200 \times 8 + 17 \times 8 = 1600 + 136 = 1736.$$

§ 9.

$$76:4 = 38:2 = 19.$$

$$236:4 = 118:2 = 59.$$

§ 10.

$$464:8 = 232:4 = 116:2 = 58.$$

$$516:8 = 258:4 = 129:2 = 64\frac{1}{2}.$$

5 25

§ 11.

5,

10/2,

:

$$74 \times 5 = 740 : 2 = 370.$$

$$243 \times 5 = 2430 : 2 = 1215.$$

$$74 \times 5 = 74/2 \times 10 = 370.$$

§ 12.

25,

100/4,

4,

4

:

$$72 \times 25 = 72/4 \times 100 = 1800.$$

4

1

25

2

50

3

75

$$100 : 4 = 25; 200 : 4 =$$

$$= 50; 300 : 4 = 75.$$

$1\frac{1}{2}$ $1\frac{1}{2}$ $2\frac{1}{2}$ $\frac{3}{4}$

§ 13.

$1\frac{1}{2}$,

:

$$34 \times 1\frac{1}{2} = 34 + 17 = 51.$$

$$23 \times 1\frac{1}{2} = 23 + 11\frac{1}{2} = 34\frac{1}{2} \quad (34,5).$$

§ 14.

$1\frac{1}{4}$.

:

$$48 \times 1\frac{1}{4} = 48 + 12 = 60.$$

$$58 \times 1\frac{1}{4} = 58 + 14\frac{1}{2} = 72\frac{1}{2} \quad (72,5).$$

§ 15.

$2\frac{1}{2}$,

:

$$18 \times 2\frac{1}{2} = 36 + 9 = 45.$$

$$39 \times 2\frac{1}{2} = 78 + 19\frac{1}{2} = 97\frac{1}{2} \quad (97,5).$$

$$\begin{array}{r}
 : \\
 18 \times 27^{1/2} = 90 : 2 = 45. \\
 \S 16. \quad 30 \times \frac{3}{4} = (30+15) / 2 = 22^{1/2} \quad (22,5).
 \end{array}$$

15, 125, 75

$$\begin{array}{r}
 \S 17. \quad 10 \times 1^{1/2} = 15. \quad 10 \\
 18 \times 15 = 18 \times 1^{1/2} \times 10 = 270. \\
 45 \times 15 = 450 + 225 = 675.
 \end{array}$$

$$\begin{array}{r}
 \S 18. \quad 100 \times 1^{1/4} = 125. \quad 100 \\
 26 \times 125 = 26 \times 100 \times 1^{1/4} = 2600 + 650 = 3250. \\
 47 \times 125 = 47 \times 100 \times 1^{1/4} = 4700 + 4700/4 = 4700 + 1175 = 5875.
 \end{array}$$

$$\begin{array}{r}
 \S 19. \quad 100 \times \frac{3}{4} = 75. \quad 100 \\
 18 \times 75 = 18 \times 100 \times \frac{3}{4} = 1800 \times \frac{3}{4} = (1800+900) / 2 = 1350.
 \end{array}$$

$$\begin{array}{r}
 \S 6: \\
 18 \times 15 = 90 \times 3 = 270. \\
 26 \times 125 = 130 \times 25 = 3250.
 \end{array}$$

9 11

$$\begin{array}{r}
 \S 20. \quad 62 \times 9 = 620 - 62 = 600 - 42 = 558. \\
 73 \times 9 = 730 - 73 = 700 - 43 = 657.
 \end{array}$$

$$\begin{array}{r}
 \S 21. \quad 87 \times 11 = 870 + 87 = 957.
 \end{array}$$

5, $1\frac{1}{2}$, 15

§ 22.

5,

$$68:5=136/10=13,6.$$

$$237:5=474/10=47,4.$$

§ 23.

3.

$1\frac{1}{2}$

$$36:1\frac{1}{2}=72:3=24.$$

$$53:1\frac{1}{2}=106:3=35\frac{1}{3},$$

§ 24.

30.

$$240:15=480:30=48:3=16.$$

$$462:15=924:30=30\frac{24}{30}=30\frac{4}{5}=30,8$$

$$(924:30=308:10=30,8).$$

§ 25.

5 (

, 85),

$$(8 \times 9 = 72)$$

25 (8)

$$7225).$$

$$25^2; 2 \times 3 = 6; 625.$$

$$45^2; 4 \times 5 = 20; 2025.$$

$$145^2; 14 \times 15 = 210; 21025.$$

$$(10x+5)^2=100x^2+100x+25=100x(x+1)+25.$$

§ 26.

5:

$$8,5^2=72,25; 14,5^2=210,25;$$

$$0,35^2=0,1225;$$

§ 27.

$$0,5=1/2, 0,25=1/4,$$

§ 25

$1/2$:

$$(8\frac{1}{2})^2=72\frac{1}{4}.$$

$$(14\frac{1}{2})^2=210\frac{1}{4}.$$

§ 28.

$$(\pm)^2 = \quad + \quad \pm 2$$

$$\begin{aligned}
 &: \\
 41^2 &= 40^2 + 1 + 2 \times 40 = 1601 + 80 = 1681. \\
 69^2 &= 70^2 + 1 - 2 \times 70 = 4901 - 140 = 4761. \\
 36^2 &= (35+1)^2 = 1225 + 1 + 2 \times 35 = 1296.
 \end{aligned}$$

1, 4, 6 9.

$$(+)(-) = ^2 - ^2$$

§ 29.

52×48.

× (50—2)

(50+2)×

$$(50+2) \times (50-2) = 50^2 - 2^2 = 2496.$$

$$69 \times 71 = (70-1) \times (70+1) = 4899.$$

$$33 \times 27 = (30+3) \times (30-3) = 891.$$

$$53 \times 57 = (55-2) \times (55+2) = 3021.$$

$$84 \times 86 = (85-1) \times (85+1) = 7224.$$

§ 30.

$$\begin{aligned}
 11^{3/4} \times 12^{1/4} &= (12 - 1/4) \times (12 + 1/4) = 143^{15/16}. \\
 1^{1/2} \times 6^{1/2} &= (7 + 1/2) \times (7 - 1/2) = 48^{3/4}.
 \end{aligned}$$

$$37 \times 3 = 111.$$

6, 9, 12

37

$$37 \times 6 = 37 \times 3 \times 2 = 222.$$

$$37 \times 9 = 37 \times 3 \times 3 = 333.$$

$$37 \times 12 = 37 \times 3 \times 4 = 444.$$

$$37 \times 15 = 37 \times 3 \times 5 = 555,$$

$$7 \times 11 \times 13 = 1001.$$

$$77 \times 13 = 1001.$$

$$91 \times 11 = 1001.$$

$$77 \times 26 = 2002.$$

$$91 \times 22 = 2002.$$

$$77 \times 39 = 3003$$

$$91 \times 33 = 3003$$

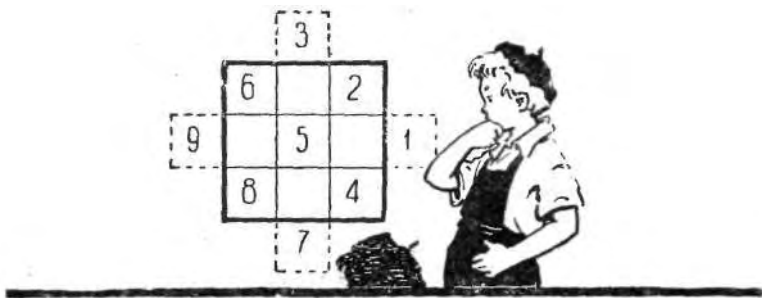

, , — -
 . (1)
 , -
 -9 ;
 , 9 -
 :

4	3	8
9	5	1
2	7	6

$$2 + 7 + 6, \quad 3 + 5 + 7, \quad 4 + 5 + 6, \quad 4 + 3 + 8,$$

15. — : — 9 ,

$$1 + 2 + 3 + 4 + 5 + 6 + 7 + 8 + 9 = 45.$$

$$45 : 3 = 15.$$

(. 250), (90°),
(. 251):

6	1	8
7	5	3
2	9	4

. 250.

8	3	4
1	5	9
6	7	2

. 251.

) 270° (— 180° () —

. 252

6	1	8
7	5	3
2	9	4

2	9	4
7	5	3
6	1	8

. 252.

9

(. 253):

6	1	8
7	6	3
2	9	4

8	1	6
3	5	7
4	9	2

2	7	6
9	5	1
4	3	8

6	7	2
1	5	9
8	3	4

4	9	2
3	5	7
8	1	6

2	9	4
7	5	3
6	1	8

8	3	4
1	5	9
6	7	2

4	3	8
9	5	1
2	7	6

. 253.

XVII : 3×3 , 5×5 , 7×7 . . .

9 , , 9
9 , ,
1 9, . 254.

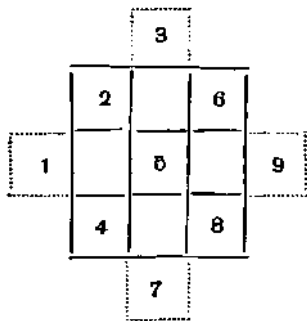

. 254.

(, ,) .

:

2	7	6
9	5	1
4	3	8

. 255

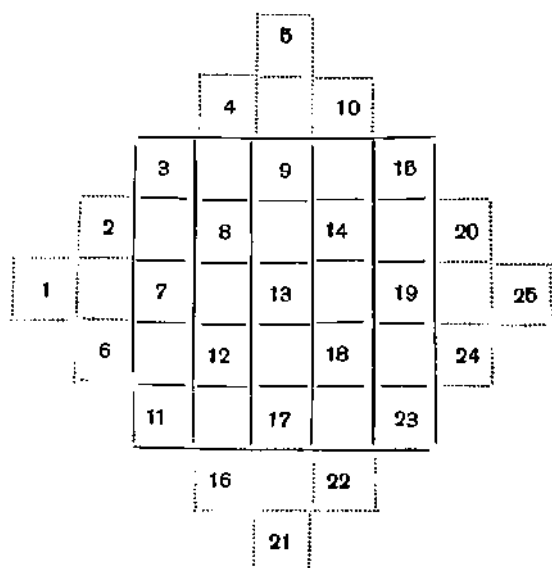

. 256.

3	16	9	22	15
20	8	21	14	2
7	25	13	1	19
24	12	5	18	6
11	4	17	10	23

. 257.

25
(. 257).

25

», —

49 (. 258).

50	39	48	1	10	19	23
38	47	7	9	18	27	29
46	6	8	17	26	35	37
5	14	16	25	34	36	45
13	15	24	33	42	44	4
21	23	32	41	43	3	12
22	31	40	49	2	11	20

. 258

- 1.
- 2.
- 3.
- 4.

—2.

1,

5.

6.

3,

1,

2—5.

49 (. 259).

32	41	43	3	12	21	23
40	49	2	11	20	22	31
43	1	10	19	28	30	39
7	9	18	27	29	38	47
8	17	26	36	37	46	6
16	23	34	36	45	5	14
24	33	42	44	4	13	15

. 259.

25 45

,
 4, 8, 12 . . . 4,
 » , . 260 «
 :
 —

-
 16;
 -
 -
 -

			X		
O					
					O
		X			

. 260.

,
 ,
 (.)
 ,
 •

8 X 8

1 64 (, 261).

—260,

1	2	3	4	5	6	7	8
9	10	11	12	13	14	15	16
17	18	19	20	21	22	23	24
25	26	27	28	29	30	31	32
33	34	35	36	37	38	39	40
41	42	43	44	45	46	47	48
49	50	51	52	53	54	55	56
57	58	59	60	61	62	63	64

. 261.

8x8 . (!) -
 36, 224 -
 (260-36); 224 , (484-
 260). 484, 56 -
 = 4x56, 224 =
 1, 2, 3, 4 57, 58,
 59, 60.

(. 359).

?

1.

(. 262).

1x	2	3	4x	5x	6	7	8x
9x	10x	11	12	13	14	15x	16x
17	18x	19x	20	21	22x	23x	24
25	26	27x	28x	29x	30x	31	32
33	34	35	36	37	38	39	40
41	42	43	44	45	46	47	48
49	50	51	52	53	54	55	56
57	58	59	60	61	62	63	64

. 262.

2.

(. 262).

3.

4.

64

(. 263).

64	2	3	61	60	6	7	57
56	55	11	12	13	14	50	49
17	47	46	20	21	43	42	24
25	26	38	37	36	35	31	32
33	34	30	29	28	27	39	40
41	23	22	44	45	19	18	48
16	15	51	52	53	54	10	9
8	58	59	5	4	62	63	1

. 263.

264.

3 4, 64

12×12, 16×16

362

	x	x	
x	x		
x			x
		x	x

1

	x	x	
x			x
x			x
	x	x	

2

x			x
	x	x	
	x	x	
x			x

3

x	x		
x	x		
		x	x
		x	x

4

. 264.

5000

4000 —

-
-
-

—« »,

-
-
-
-

•
•

•

,

,

,

•

-
-
-
-



28

28

?

28

5

?

27

: 27

65

27

?

?

. 265

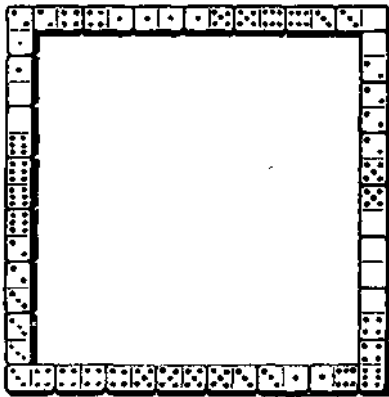

. 265.

59 32.

44

44?



. 266.

. 266:

366

11.

?

. 267

— : 13.

18

. 13—

18

23.

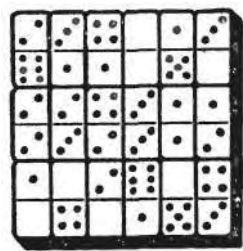

18

. 267.

. 268

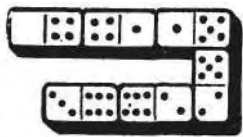

. 268.

() 4, : -
: 4; 5; 6; 7; 8; 9.

() , « »

6

„ 15”, „ ”
15

« — 70 —
« 15»; —

.
 .
 .
 . «
 , —
 1880
 . » , —
 ;
 1000
 ;
 ()
 «
 »
 ».
 ».
 ».
 ».
 1
 »

« , 70 , — , —
 « 15». 15
 14 15 (. 270).
 , , , 14 15

1	2	9	4
5	6	7	8
9	10	11	12
13	14	15	

. 269.
 (I).

1	2	3	4
5	6	7	8
9	10	11	12
13	13	14	

. 270.
 (II).

1000

».

(« »).

«
15
2, 3, : 5, 6, 7, 8 . . . 4; 1, . 269. 15
1
2 1, 1 2,
3 4 ;
1, 2, 3, 4
: 5, 6, 7, 8;
2, 3, 4, 5, 6, 7, 8, 9 13 9 13; 1,
; 10, 11, 12, 14, 15
10, 11, 12.
14 15
(. 270).
. 269, I, . 270,
II.
S,
— I,
S. I 12 : ,
I

,
 ,
 — II. , , I,
 , II — .
 , , , .
 — I II? (

1) , I — :
 II ; 2) ,
 , — , ,
 , ? .
 , , 271.

, (9).
 , 8. 9 ,
 , 8: « ».
 9 :
 .
 (12, ¹⁴13, 11) . 271.

1	2	3	4
5	6	7	9
8	10	14	12
13	11	15	

(14 ¹²14 : 13, 14 11).
 1 + 3 = 4
 11, 13
 12
 11.
 ; , , , .

».

. 270,

(. 272).

	1	2	3
4	5	6	7
8	9	10	11
12	13	14	15

. 272.

. 270,

. 273.

1	2	3	4
5	6	7	8
9	10	11	12
13	14	15	

. 273.

(. 270).

30.

„ **11''**

11 (-

. .).

?

„ **15''**

« 15»

1 9,

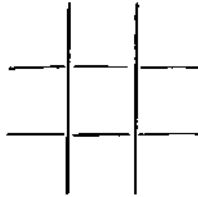

(15.),

15

?

„ **32''**

32

. . . , -
 , , , -
 ? , -
 « 32» : ,
 , , , ?

» 27''

« 27» : -
 , -
 ?

- 1) ; () ;
 2) () ;
 3) .
- 1 6 (, 100, 10×10
). . 274. 1

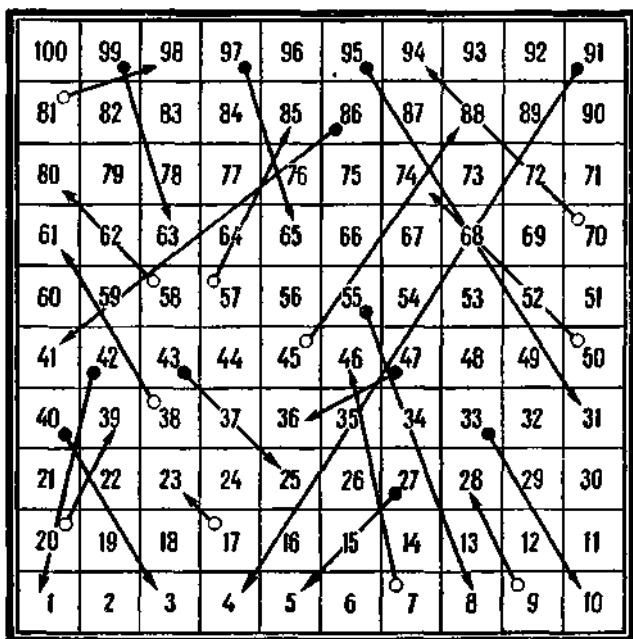

. 274.

6

6.

1

3. (10)

2.
3.

2.
4.
19.

У вас теперь 21

2

5. (10)

14.
8.

3.
10.

У вас теперь 12

3

10
()
29.

10.
4.
3.
2.

У вас теперь 100

4

10
()
5.

2.

10.
3.

У вас теперь 37

377

5

10

()

25.

3.

4.

7.

У вас теперь 16

6

7.

110.

15.

9.

3.

У вас теперь 150

378

7

100

12.
130.
5.

120.
7.

1.

30.

У вас теперь 40

8

()

1. 5.

У вас теперь 7

379

9

100

20.

170.

6.

1.

8.

У вас теперь 48

10

7.

11.

У вас теперь 8

380

, , , : -
 , - -
 , — , . -
 . -
 » « »: 10— 0 9; « -
 ?.. 5; -
 . -
 2. 5?.. ?.. , 7. ,
 ; ?.. , 4. 3.
 9. , ?.. ,
 ? 17. ? !
 ?.. , ,
 , ?.. 5.
 , ?.. 7. , 3. 6. -
 , ?
 , 15.
 ? ,
 ? .. ?
 , 8. :
 3. , 7. :
 12. -
 ? -
 , ;
 , ;

, : ?
 ; 5.
 5, 10.
 387,
 : $3 \times 2 = 6$.
 5. $6 + 5 = 11$.
 5. $11 \times 5 = 55$.
 : $55 + 8 = 63$.
 10. $63 \times 10 = 630$.
 : $630 + 7 = 637$.
 637
 ?

1.
 3. 1.
 4, 4
 12.
 13. 39.
 1 —
 3 —
 1 — 40.
 : $40 + 12 = 52$.
 52, 4,
 382

48

4.

12— ,

?

?

:

,

,

(,),

3857.

:

3857,

8735,

$8735 - 3857 = 4878$.

7,

:

8,4,8.

?

?

:

10,

73,

5,

17

17

8

$$\begin{aligned}
 17 \times 2 &= 34, \\
 34 \times 10 &= 340, \\
 340 + 73 &= 413, \\
 413 \times 5 &= 2065, \\
 2065 + 8 &= 2073.
 \end{aligned}$$

2073

?

?

1;

23

25,
 275,
 572,
 572 275 = 297,
 297 + 792 = 1089,
 1089 + 23 = 1112.

1112

?

?

3;

5;

20;

2;

5.

$$\begin{aligned}
 &: \\
 4 + 3 &= 7, \\
 7 \times 5 &= 35, \\
 35 + 20 &= 55, \\
 55 \times 2 &= 110, \\
 110 + 7 &= 117, \\
 117 + 5 &= 122.
 \end{aligned}$$

122

?

648.

$$\begin{array}{r}
 846 \\
 - 648 \\
 \hline
 198
 \end{array}$$

$$\begin{array}{r}
 198 \\
 + 891 \\
 \hline
 1089
 \end{array}$$

108

(),

1089).

9

(

!

(099).

(99),

?

?

$$6 \times 2 = 12.$$

7:

$$12 + 7 = 19.$$

5:

$$19 \times 5 = 95.$$

(3):

$$95 + 3 = 98.$$

$$98 - 35 = 63,$$

$$6 - 3.$$

35?

50

387.

A 24 020	B 36 030	C 48 040	D 51 0 060	E 612 060
A1 34 212	B1 46 223	C1 58 234	D1 610 245	E1 712 256
A2 44 404	B2 56 416	C2 68 428	D2 7 104 310	E2 3 124 412
A3 54 616	B3 66 609	C3 786 112	D3 8 106 215	E3 9 126 318
A4 64 828	B4 768 112	C4 888 016	D4 9 108 120	E4 10 128 224
A5 750 310	B5 870 215	C5 990 120	D5 10 110 025	E5 11 130 130
A6 862 412	B6 972 318	C6 1 092 224	D6 11 112 130	E6 12 132 036
A7 964 514	B7 1 074 421	C7 1 194 328	D7 12 114 235	E7 13 134 142
A8 1 056 616	B8 1 176 524	C8 1 296 43 2	D8 13 116 340	E8 14 136 248
A9 1 158 718	B9 1 278 627	C9 1 398 536	D9 14 118 445	E9 15 138 354

, « 4»,

10 128 224.

50

?

25,

— 20—

?

)

. 275.

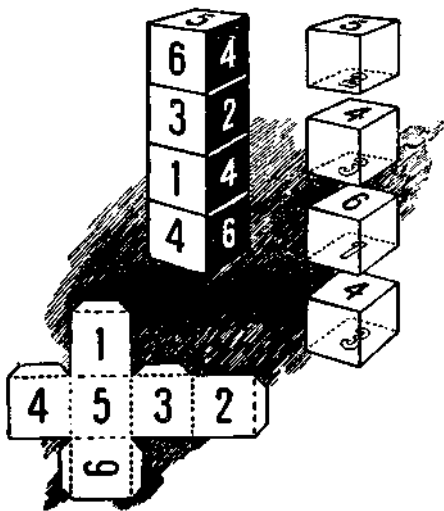

. 275.

23.

. 276.

39	63	54	38	45	61	49	33
53	<input type="checkbox"/>	57	46	43	41	<input type="checkbox"/>	62
34	40	<input type="checkbox"/>	55	42	51	59	35
60	32	44	58	<input type="checkbox"/>	58	<input type="checkbox"/>	58
36	48	50	56	52	47	42	37

45	63	27	10	58	9	61	42
29	8	11	57	30	59	<input type="checkbox"/>	62
13	24	<input type="checkbox"/>	60	40	47	14	56
46	<input type="checkbox"/>	12	44	<input type="checkbox"/>	25	<input type="checkbox"/>	27
43	15	41	31	26	62	12	28

33	49	27	17	21	55	61	39
8	<input type="checkbox"/>	31	51	63	43	<input type="checkbox"/>	13
16	?	1	19	15	23	59	41
57	<input type="checkbox"/>	20	9	<input type="checkbox"/>	35	<input type="checkbox"/>	61
53	6	47	25	45	33	11	37

54	23	18	58	63	31	26	51
29	<input type="checkbox"/>	61	50	20	27	<input type="checkbox"/>	62
56	28	<input type="checkbox"/>	17	59	48	21	60
31	<input type="checkbox"/>	19	55	<input type="checkbox"/>	30	16	53
63	49	24	57	22	52	27	25

5	47	23	53	61	13	20	52
37	<input type="checkbox"/>	44	30	46	55	4	7
22	63	<input type="checkbox"/>	12	62	14	60	31
23	<input type="checkbox"/>	28	54	<input type="checkbox"/>	15	<input type="checkbox"/>	6
46	36	39	21	45	28	63	38

11	38	62	51	43	26	55	15
10	<input type="checkbox"/>	63	35	31	19	<input type="checkbox"/>	46
14	3	<input type="checkbox"/>	59	27	7	58	18
26	<input type="checkbox"/>	6	47	2	39	<input type="checkbox"/>	22
54	23	50	30	35	42	11	34

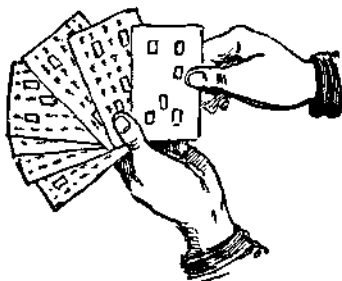
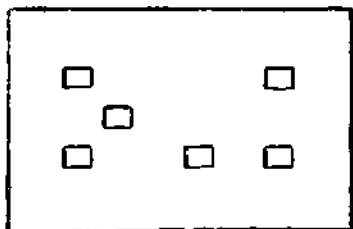

. 276.

»), («

?

84 706,

1-е слагаемое	84 706
2-е «	
3-е «	
Сумма		184 705

1-е слагаемое	84 706
2-е «	30 485
3-е «	69 514
Сумма		184 705

?

« 1. 1. 1.» —

1769 . . . 15

1769
15
8 (авг.—8-й мес.)

Итого 1792

1
7
9
2

Итого 191

Наполеон умер 5 мая
1825 года.

1825
5
5 (май—5-й мес.)

Итого 1835

1
8
3
5

Итого 171

1811 . . . 7

1811
7
1 (январь—1-й мес.)

Итого 1819

1
8
1
9

Итого 191

Илья Теглев умер 21 июля
1834 года.

1834
21
7 (июль—7-й мес.)

Итого 1862

1
8
6
2

Итого 171

...

. 1916
« »

-
-
-

:

II

1859	1830
1888	1848
57	86
<u>28</u>	<u>68</u>
3832	3832

—
...

1916

-
-
;
;

—

:

?

-
-
;
-
-
-
:

1916

(.),

(.).

: 0—0, 1—1, 2—2 . . . 21 -
 , 4 () -
 : 4—0; 4—1; 4—2; 4—3; 4—5; 4—6. -
 , , , , -
 . , 21 0—0, 1—1, -
 2—2 . . . , -
 28 , -
 , 28 -
 , , , (-
 ,) . , , -
 , . , -
 : , (-
 , , « -
 ».) -
 , : 28 -
 , , .

()

: 7 959 229 931 520

(: $2^{13} \times 3^8 \times 5 \times 7 \times 4231$).

28

1) 27

2)

$44 \times 4 = 176,$

(168).

: 8.

277.

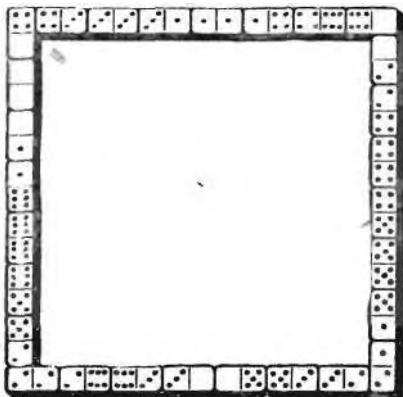

. 277

(. 278,) :

1				3,	2			9,
1	«	«	«	6,	1	«	«	10,
1	«	«	«	8,	1	«	«	16.

(. 278,):

2			4,	2			10,
1	«	«	8,	2	«	«	12.



. 278.

. 279
18.

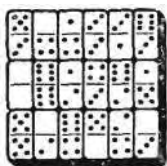

. 279.

) 0—0; 0—2; 0—4; 0—6; 4—4 (3—5); 5—5 (4—6).
) 0—1; 0—3 (1—2); 0—5 (2—3); 1—6 (3—4);
 3—6 (4—5); 5—6.

) 1:

0-0,	1-1,	2-1,
0-1,	2-0,	3-0,
1-0,	0-3,	0-4,
0-2,	1-2,	1-3,
2-2,	3-2,	
3-1,	2-4,	
1-4,	3-5,	
2-3,	3-4,	

) 2:
0-0, 0-2, 0-1.

„ 15", „ ”

44 :

14,	11,	12,	8,	7,	6,	10,	12,	8,	7,
4,	3,	6,	4,	7,	14,	11,	15,	13,	9,
12,	8,	4,	10,	8,	4,	14,	11,	15,	13,
9,	12,	4,	8,	5,	4,	8,	9,	13,	14,
10,	6,	2,	1.						

39 :

14,	15,	10,	6,	7,	11,	15,	10,	13,	9,
5,	1,	2,	3,	4,	8,	12,	15,	10,	13,
9,	5,	1,	2,	3,	4,	8,	12,	15,	14,
13,	9,	5,	1,	2,	3,	4,	8,	12.	

30

:

12,	8,	4,	3,	2,	6,	10,	9,	13,	15,
14,	12,	8,	4,	7,	1?,	9,	14,	12,	8,
4,	7,	10,	9,	6,	2,	3,	10,	9,	6,
5,	1,	2,	3,	6,	5,	3,	2,	1,	13,
14,	3,	2,	1,	13,	14,	3,	12,	15,	3.

„ 11''

;

,

;

,

,

,

,

„ 15''

?

5.

1.

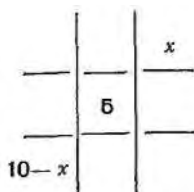

$\frac{15-5}{2}$ ($\frac{\quad}{10}$, , 9.).

$y=10-$;

$=10-$.

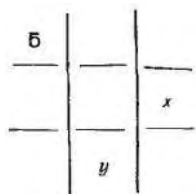

3.

	x	z
б		
	y	t

$$z = 10 - z; \quad t = 10 - z; \quad z = 15 - t.$$

„ 32”

11 6 ; — 16, 21, 26 31 11 26, 21, 16,

„ 27”

32. 1. 2. 6, 5, 11, 17, 23; 13, 18 19, 24 25. 6 7, 12 27

23.

$$1. \quad (a+2) \times 3 + \dots = 10a + 6.$$

$$170 - (\dots + 20) - 6 + \dots = 144.$$

$$1001 = 7 \times 11 \times 13.$$

$$1001 (\dots , 356 \times 1001 = 356356).$$

$$\frac{a \times 1001}{7 \times a \times 11} = 13.$$

, , -
 , ,
 2X5, 10, 2, 5;
 , 10, -
 7;
 : , -7. -
 ? , 7. , -
 ; , , 17.
 , , , , -
 , , , , -
 , , , , -
 , , , , ?
 3X3+1, 10, : , -
 , , , , -
 , , , , .
 , , , , ?
 2 x 2 x 2 + 1 + 1, ?
 1 10. 0, : , -
 , , , , -
 , , , , .
 , , , , 2,

5, 10, 10, $2 \times 5 \times 10$, 100.
 . 250, , 5 \times 5 \times 10,
 10, , 100, 250, :
 . , 250. : -
 , , 4, 4. , 4 -
 ?
 , 9, 9 ,
 , , ; 9. , 9 -
 (,). 9 -
 20, 9. , , 8, 4, 8 -
 20 9. , , 7, ?
 365; , — . -
 2073—365=1708.
 17—08 : 17/VIII. -
 , — N , -
 .

$$(2 \times 10 + 73) \times 5 + N = 100 + N + 365.$$

?

$$\frac{1089}{1089}$$

1089

9

?

75.

$$122 - 75 = 47.$$

$$[(a + 3) \times (5 + 20)] \times 2 + a + 5 = 10a + a + 75,$$

: 1089.

() 108

?

2, 5, 10, 5;
 $7 \times 5 = 35.$ 35,

20, -30, -40, *D*-50, -60.
 , 1-21, 3-43, 5-65.

4, 64.
 $6+4=10.$
 $64 \times 2 = 128.$
 $6-4=2.$
 $6 \times 4 = 24.$
 10 128 224.

+, 2, , ×,

D3.

?

$$\begin{aligned} D3 &= 53, \\ 5 + 3 &= 8, \\ 53 \times 2 &= 106, \\ 5 - 3 &= 2, \\ 5 \times 3 &= 15. \end{aligned}$$

8 106 215.

8.

?

$$\begin{aligned} 8 &= 38, \\ 3 + 8 &= 11, \\ 38 \times 2 &= 76, \\ 8 - 3 &= 5, \\ 8 \times 3 &= 24. \end{aligned}$$

1 176 524.

,

-

,

,

,

,

,

:

-

:

,

-

(. 275).

,

-

, $7 \times 4 = 28.$

28

,

-

,

100000—1,

99999,

99 999

+ 84706
99999,

: 184 705.

99999.

30 485;

69 514.

30485
+ 69514
99999,



()

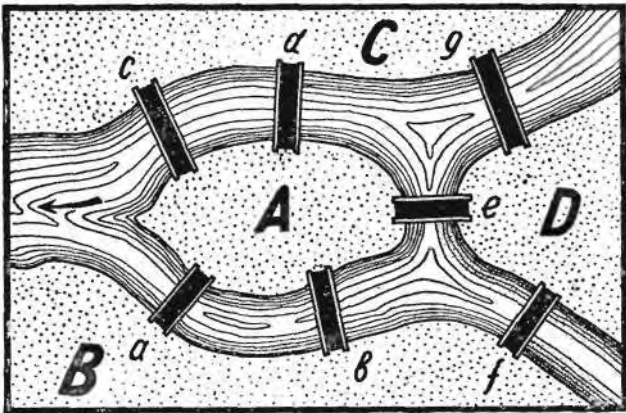

«¹ , (. 280),
: . , , d, e, f, g

?

, , ? ».

?

, 1736
:

« , « ».

²

, ».

(. 281).

(, ,

¹
²

« »;

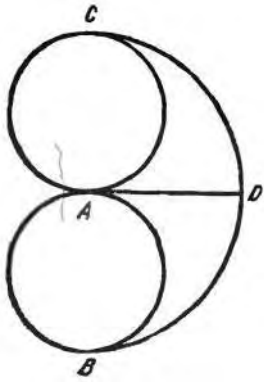

.281.

:
).
 , ~ , D (. 280)
 ,
 .
 (. 281)
 ,
 ,
 ,
 ,
 ,
 , D

;
 ;

,
 ,
 ,
 — ,
 , , , D
 ;
 ,

(. 282)

1-6

,
 ,
 ,
 ?
 ,

, ?
 ,
 .
 « »
 , « »
 (,),
 ,
 , —
 ,
 , 1 5 (. 282).
 ,
 (,).
 ,
 2, 3, 6; 6. -
 ,
 .
 4 7,

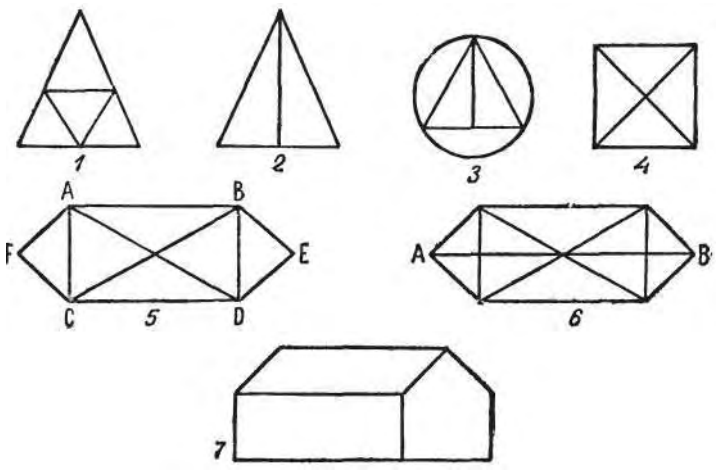

, ' ,
 : «
), , (,
 : ABCD. ».
 AFC, (—ACF 5 DA, BDE,)
 ABCD, DBED BDE,
 DA DA,
 DA AFC.

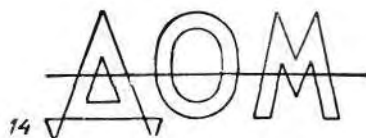
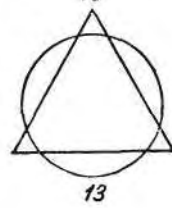
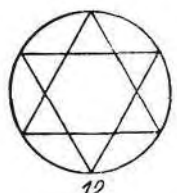
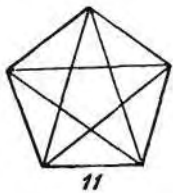
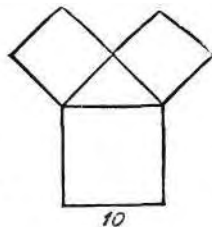
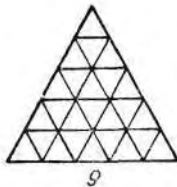
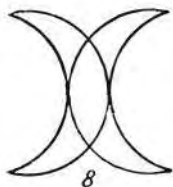

. 283.

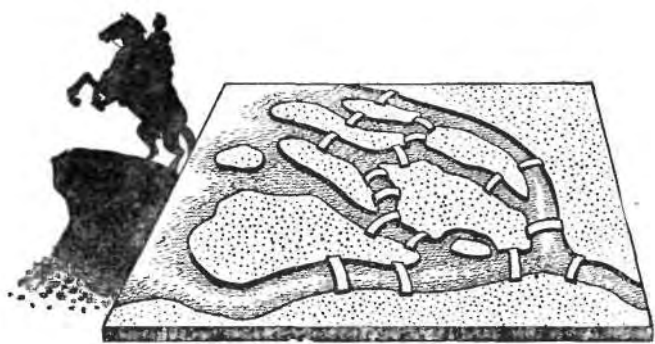

.284.

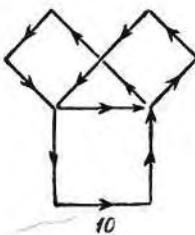
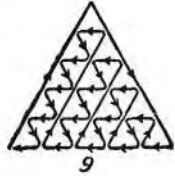
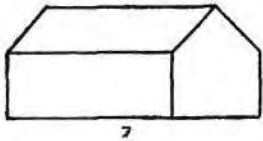
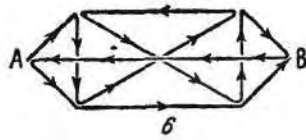
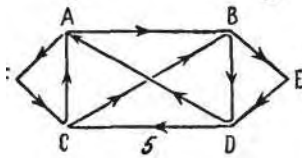
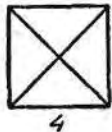
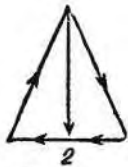
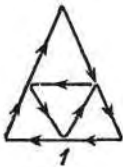

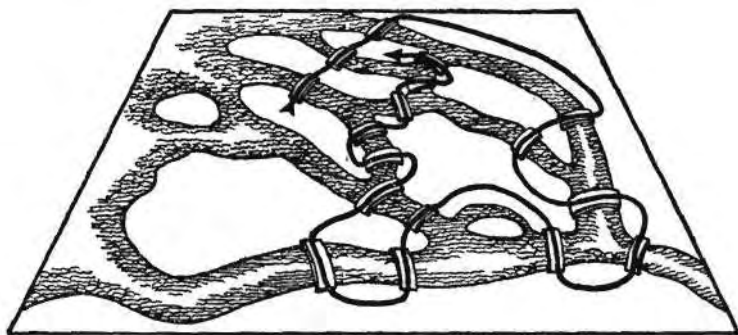

. 286.

. 285 286

«

».



, ?

, , , , , ?

?

. 287.

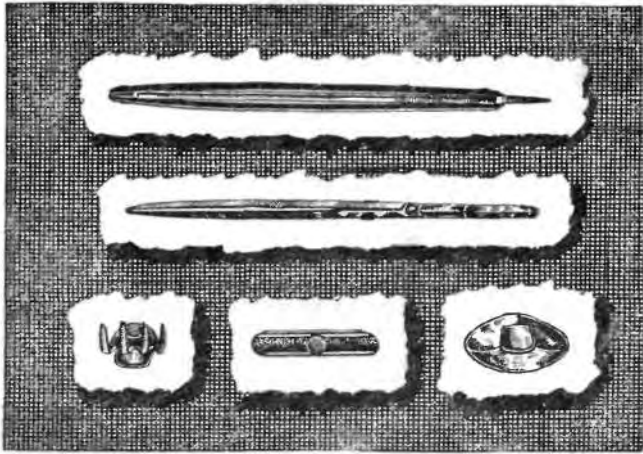

. 287.

(. 288).

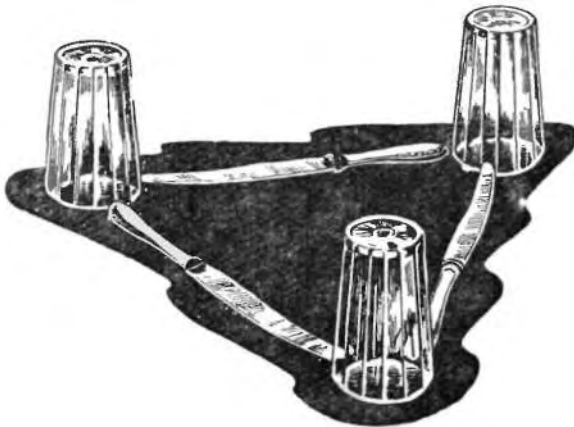

. 288.

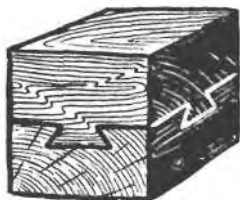

. 289.

(. 290)

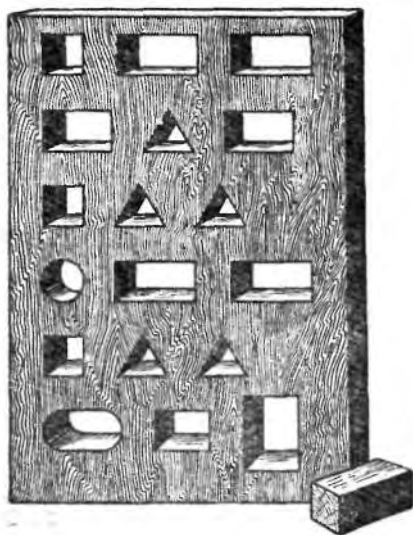

. 290.

(. 291)

?



. 291.

. 292?



. 292.

. 293?

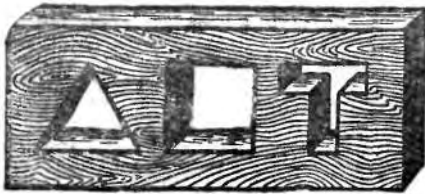

. 293.

(. 294). , ? $1\frac{1}{2}$



. 294.

?

(. 295)

?

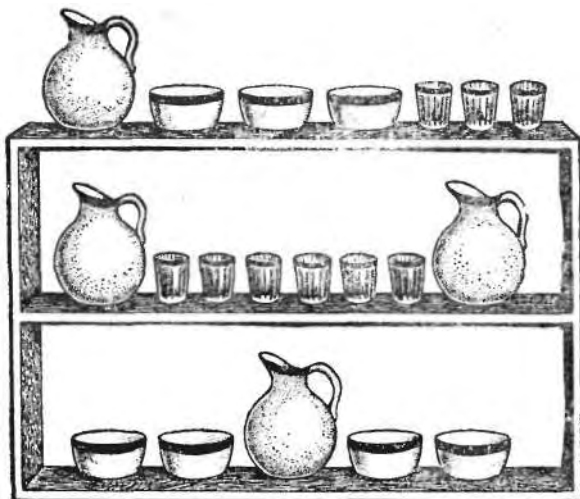

. 295.

?

10

12

(.296),

6 , 8 ,

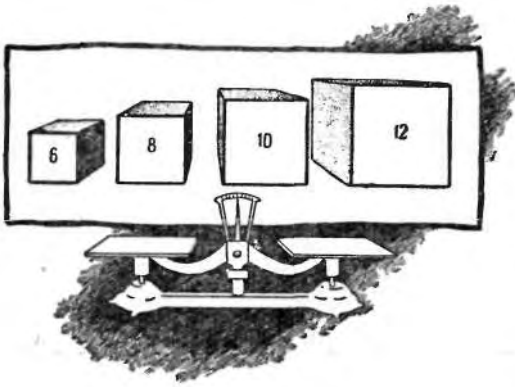

.296.

()

?

?

?

(. 297).

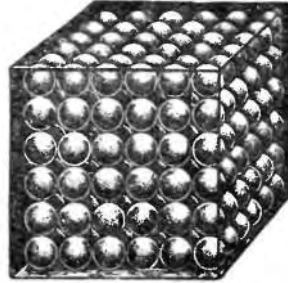
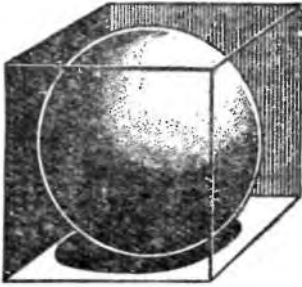

. 297.

?

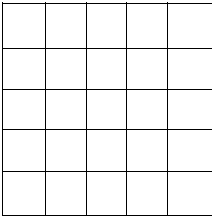

. 298.

?

(. 298)?

?

4 .

?

1 ?

2

?

$1\frac{1}{2}^\circ$

(. 299)?

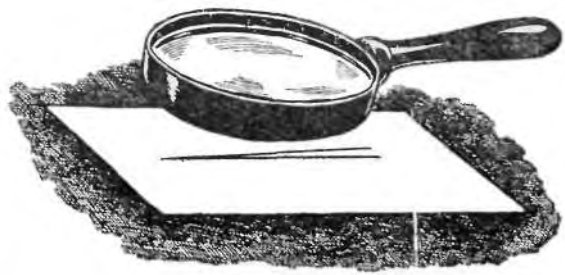



. 300.

1.

? (. 300)

2.

(? . 300)

∴ ?

3

301).

20 ;

10

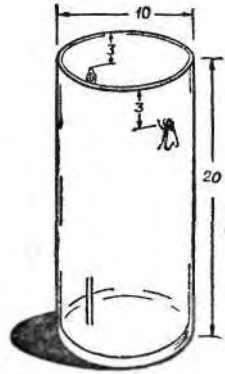

. 301.

, 20

(. 30
302).

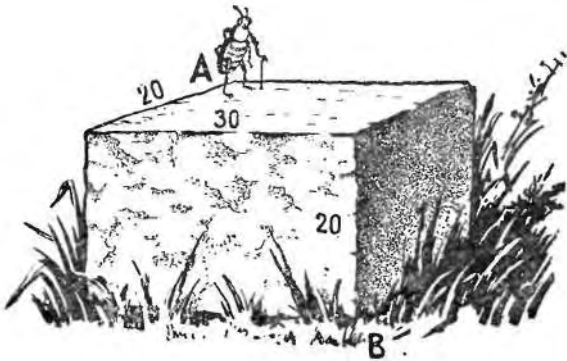

. 302.

?



. 303

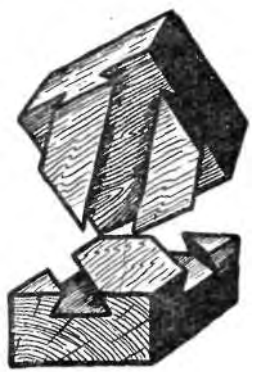

. 304.

. 303.

. 304.

(,)



. 305.

. 305.



. 306.

. 306.

. 307:

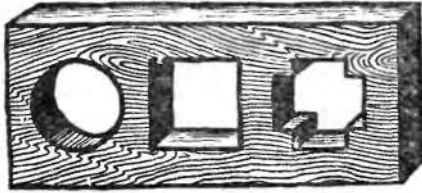

. 307.

. 308.

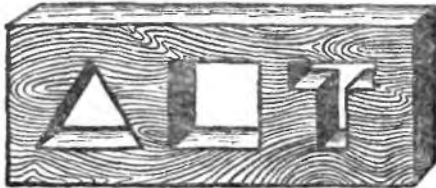

. 308.

$$\left(1\frac{1}{2}\right)^2 = 2\frac{1}{4}$$

?

12

$$2 \times 2 =$$

$$6^3 + 8^3 + 10^3 = 12^3,$$

$$216 + 512 + 1000 = 1728.$$

(. 308).



. 308

?

$$6 \times 6 \times 6 = 216. \quad 216$$

216

225.

16, 25, 36, 49

64

64

4, 9,

<< 4 <<
 << 9 <<
 << 16 <<
 << 25 <<
 << 36 <<
 << 49 <<
 << 64 <<

64
 49
 36
 25
 16
 9
 4
 1
 221

224

$$4000 : 64 = 62,5$$

$$7 \times 7 \times 7 = 343$$

$$2 \times 3,14 \times (R + 175) = 2 \times 3,14 \times R = 2 \times 3,14 \times 175 = 1100$$

$$1\frac{1}{2} \times 4 = 6^\circ$$

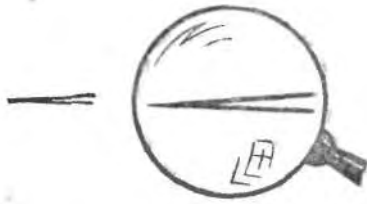

. 309.

. ' . 309

;

,

,

,

() —

—

,

—

).

,

,

2:1.

4:1.

,

. 310.

4:3,

2:1,

,

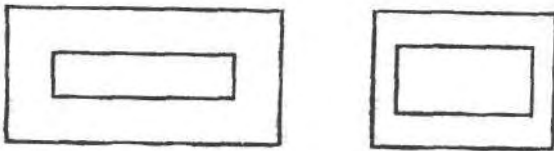

. 310.

, -
 , 95 , 19 -
 ; -
 , 14 ,
 , .
 , , -
 , -
 95 :19, 5; ;
 14 × 5 = 70 . 70 .
 , , , -
 , , ,
 .
 ?
 . -
 1000 , 1 : 1 ; .

... 1000 . :
 : 1000×1000×1000. 1000 -
 1000 = 1 , 1000 . , 1000 -
 , .

100

100

$100 \times 100 \times 100,$

100

60

()

(. 311,)

$10 \times 3^{1/7} = 31^{1/2}$ ()

17

$15^{3/4}$

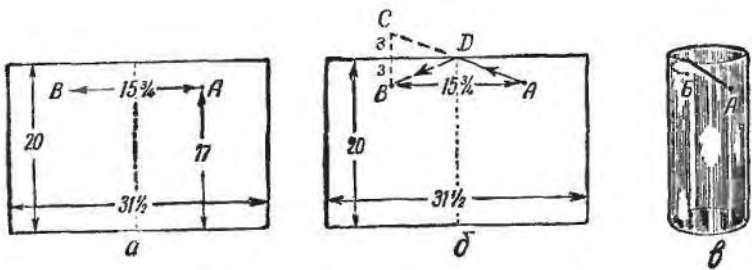

. 311.

(. 311,)

D , ADB

(. 311,).

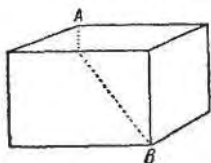
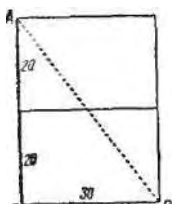

(. 312).

. 312

ABC , $= 40$, $= \frac{30}{50}$

$$30^2 + 40^2 = 50^2$$

$= 50$

« »
« »

60

45

ABC ,

15, 5; 9 12, 3 4, 3x15

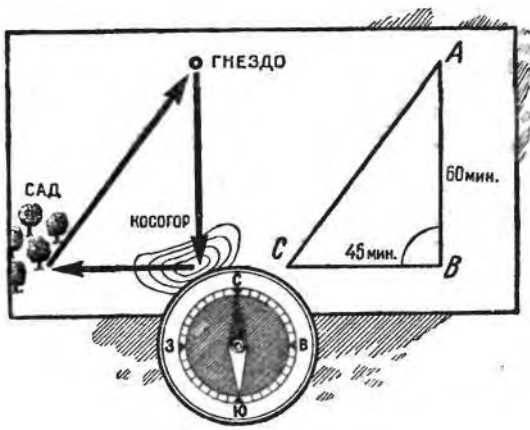

. 313.

$$= 5 \times 15 - 4 \times 15 = 75 - 60 = 15$$

$$1 + \frac{3}{4} + \frac{1}{4} = 2$$

$$\frac{1}{2} + \frac{1}{2} = 1$$

4 (, 4000 , 4) —
13 . . .



20

20

10;

50

250,

$$2 \times 250 + 3 \times 50 + 4 \times 10 = 690.$$

$$1,1n^3 - 1,2n = n, \quad 1,2 = 1.$$

$$= 0,83$$

175

(. 314) —

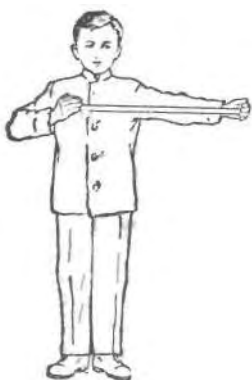

315,).

. 314.

10 ;

. 315,

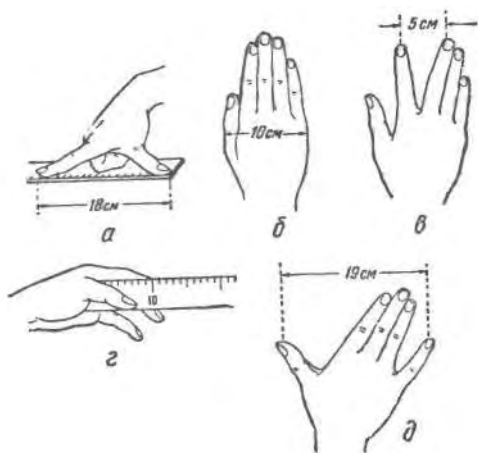

. 315.

(. 315,).

. 315, . , ,
 . 315, . « » , -

()
 , $1\frac{1}{2}$ -
 $4 - 2\frac{1}{2}$ (. 316), ,



. 316.

. $1\frac{1}{2}$
 $2\frac{1}{2}$ «
 3 «
 4 «
 5 «

1 . , -
 2 3 , -
 , 4 . 4 , -

4 1.

()

—1, 2 —2 . . .

1—10

15 1,956 2

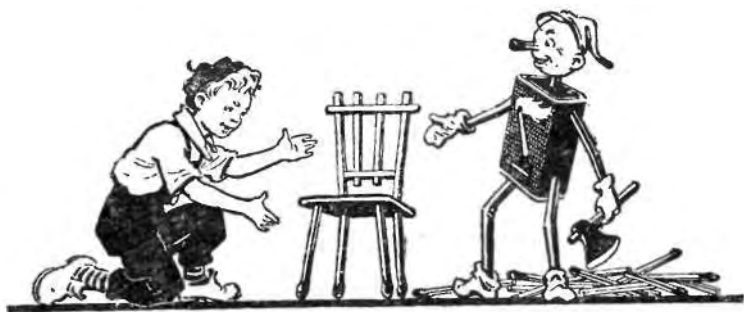

1
 (. 317,)
 12

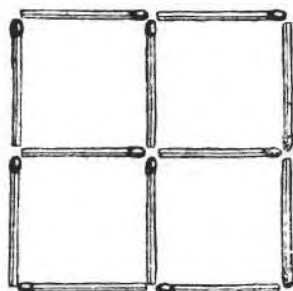

a

. 317.

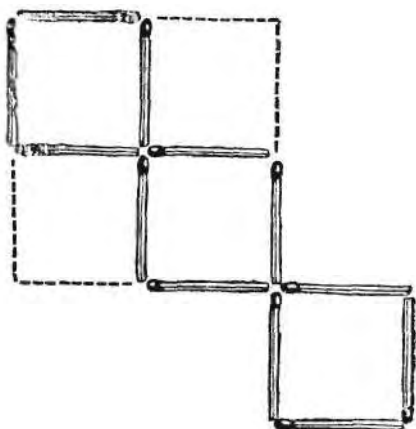

. 317, ,

. 317.

δ

2

, 318, :

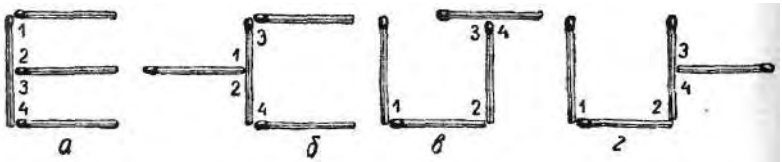

. 318.

1, 2, 3, 4.

. 318,

. 319.

. 319,

(. 319,

):

, « ».

. 319.



200

()

(. , « » , 1907).

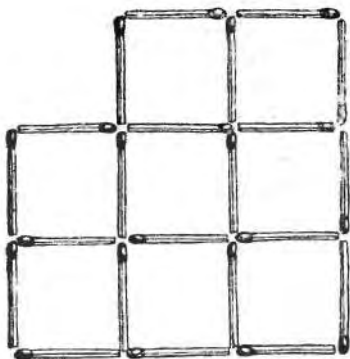

)
,
)

3

(. 320)..

. 320.

4

(. 321),

).

(

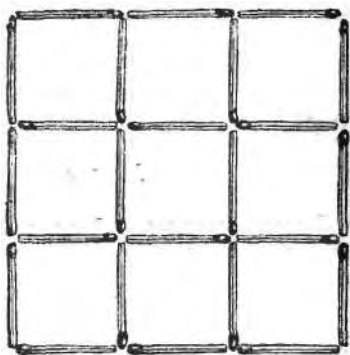

-
-
-
-
-
-

. 321.

5

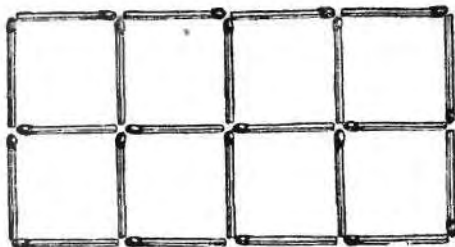

(. 322),

. 322

6

(. 321)

7

(. 323).

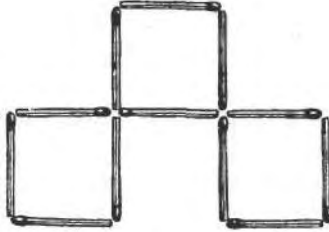

. 323.

8

10

(. 324),
().

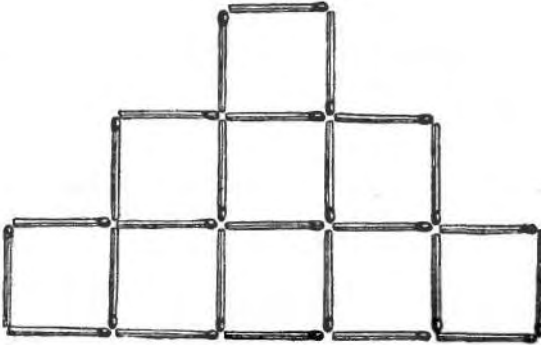

. 324.

9

12

(. 322)

(. 322)

10

11

12

**

13

18



325).

14

10

(.

. 325.

15

12

16

(. 326),

).

(

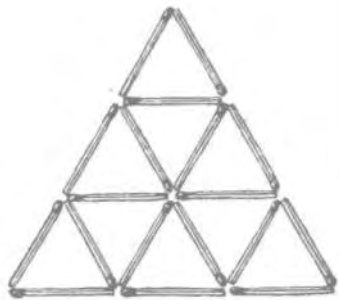

. 326.

17

18

18

(. 327).

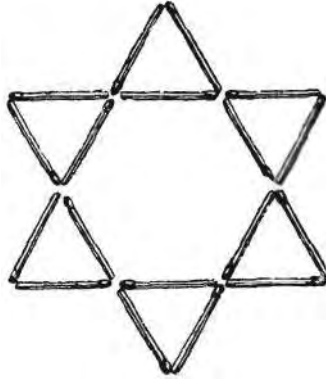

. 327.

10

19

?

20

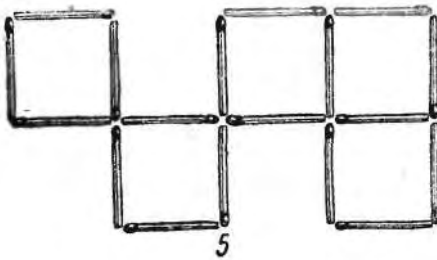
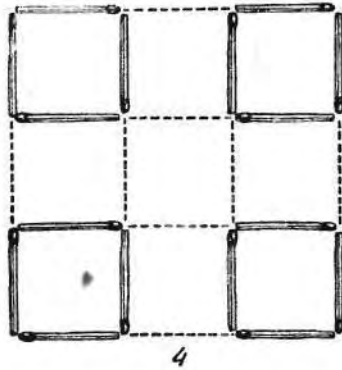
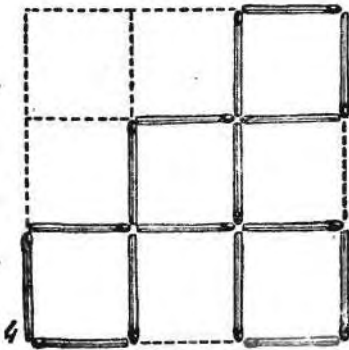
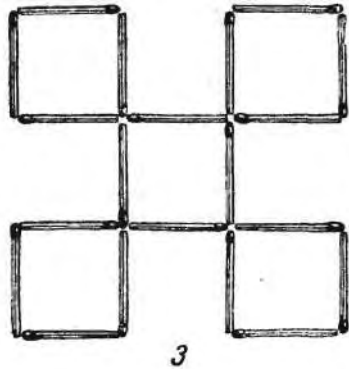
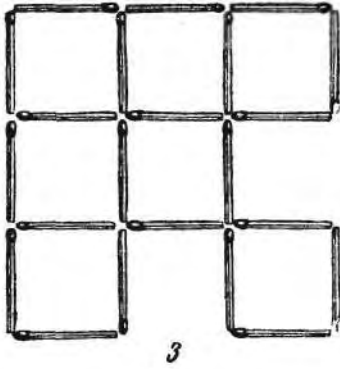

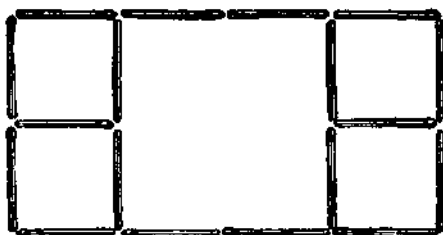

5

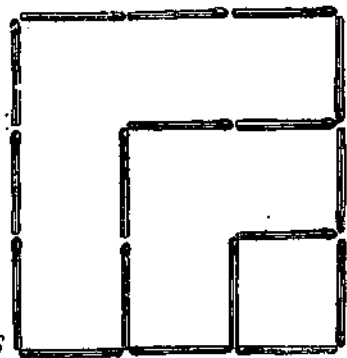

6

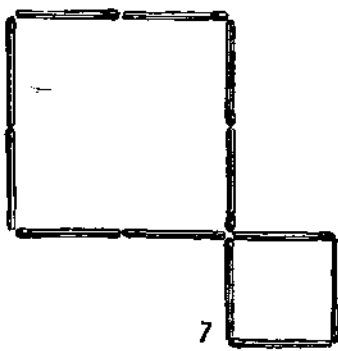

7

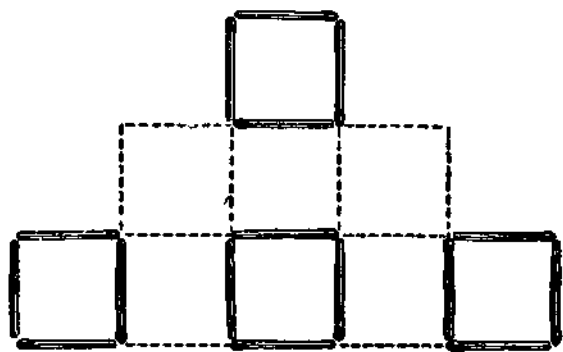

8

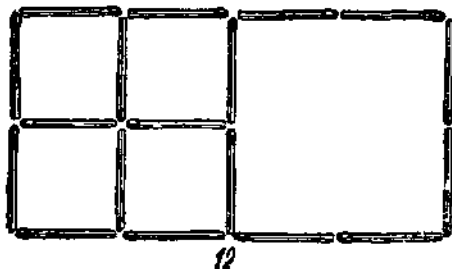
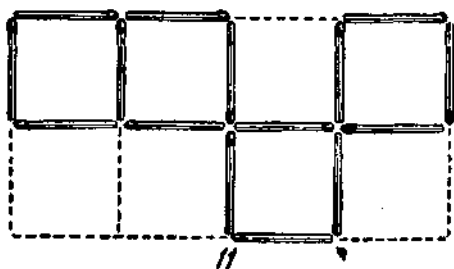
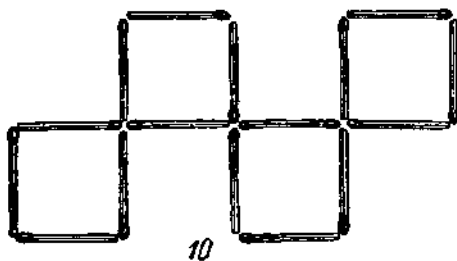
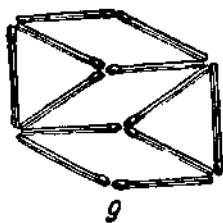

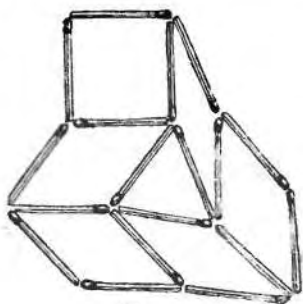

13

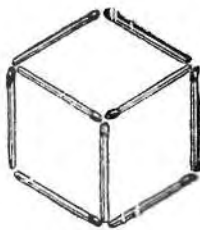

14

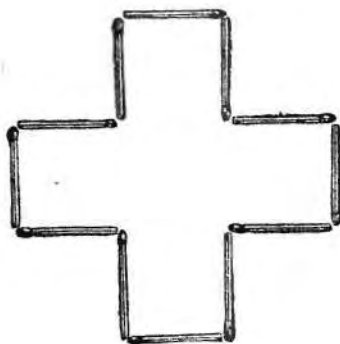

15

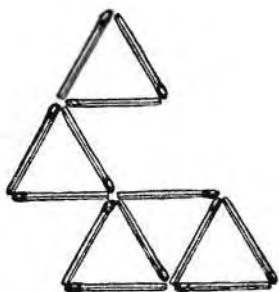

16

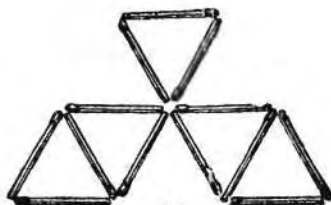

16

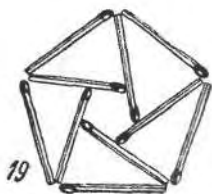
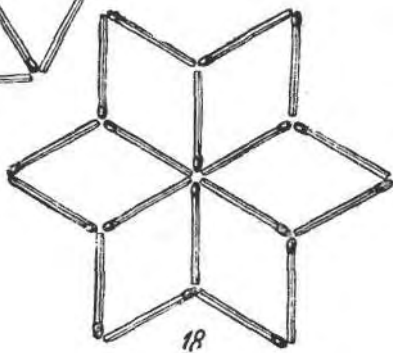
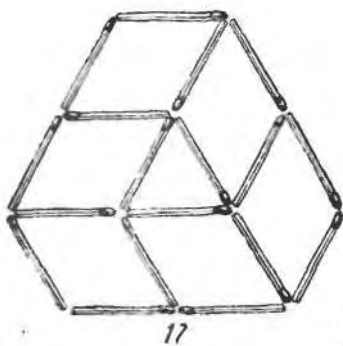

20.

« , ».

. 328.



. 328.

,
 .
 . 328.
 ,
 ,
 ()

;
 ;
 ()
 ,
 ?
 ,
 ,
 :

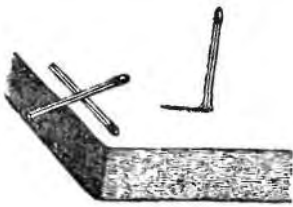

. 329)

. 329.

?

« »

$$\begin{aligned}
 + 1 &= \\
 + 2 &=
 \end{aligned}$$

„ 20''

$$n+1, \quad 2(n+1), \quad 3(n+1), \quad 4(n+1) \dots$$

$$a/(n+1)$$

$$r, \quad r, \quad r,$$

$$r+(r+1), \quad r+2(n+1), \quad r+3(n+1) \dots$$

- 1) 15; — ;
- 2) 25; — ;
- 3) 30; — ;
- 4) — .

« » — (. 330).



. 330.

(VII) (VI),

$$3+2=8!$$

... !

III + II = VIII.

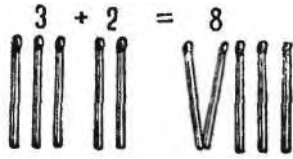

. 331.

48

?

(48),

16

16

16

16

16,

16 + 8 = 24.

:

8

16

24

, ,
24—

-
-
-
:

8

28

12

, ,
:

,

22

14

12

, ,
,

-
-

, , :

-



, :



, , « »
!

! ? :
 , , ? -
 (, —), , -
 99 100 , -

. 332
 5 , —
 : $5 \times 10 = 50$
 ? 25
 () :
 . 332,

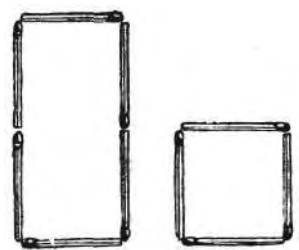

(. 333).

 . 333.

?

(. 334).

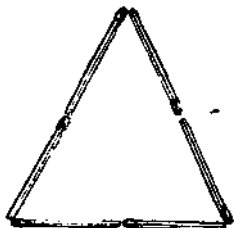
?



. 334.

. 335.

?

2.

3 (

)

1

1, 4, 5.

(1

).

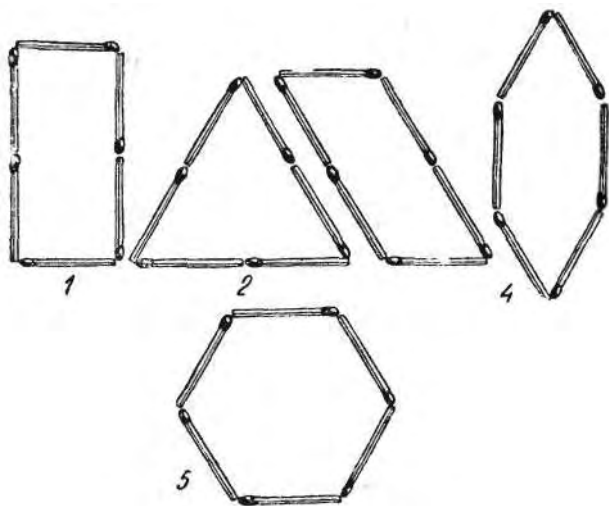

. 335.

5; , ' , ' -

. 336

? , , -

), $1\frac{1}{2}$ (. 337,).

1

».

«

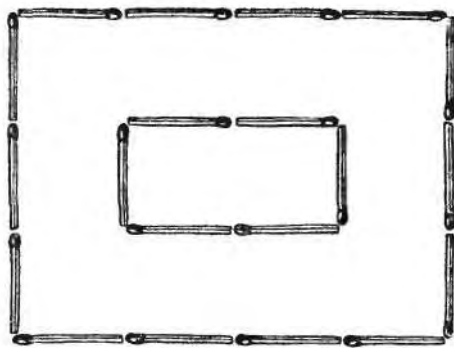

. 336.

5-6, . 337, 7-4. 2-7,
 , 5-7; 2-4, 2-7
 , 1 1/2 ; 7-4 -
 , ,

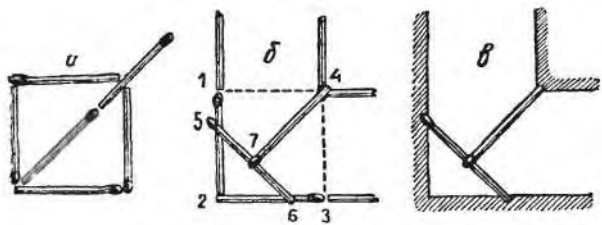

. 337.

(, ,) , -
 , , (. 337,). ,

1. ; , 10 -
 ; , : , -
 1/10 ?

2. ?

1 , — , 2 : , 1/2 ! -
 , 10 , 10 -
 ?

10 ; 10 -
 1000 : 1/10 × 1000 = 100 -
 1000 , , , 50 -

? , : -
 , -
 , 1 1/2



. 338.



. 339.

. 339, 340, 341, 342

(

).



. 340.



. 341.



. 342.

. 343—346,

. 343

. 344 —

. 345—

. 346

« ».

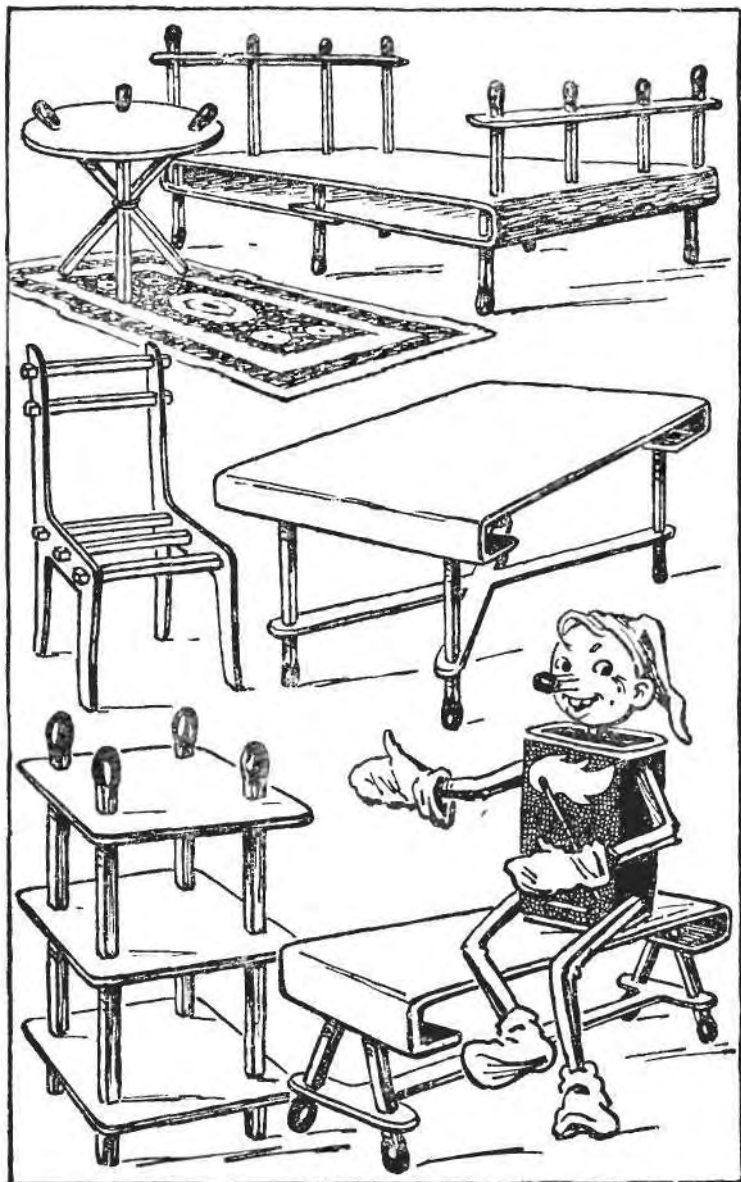

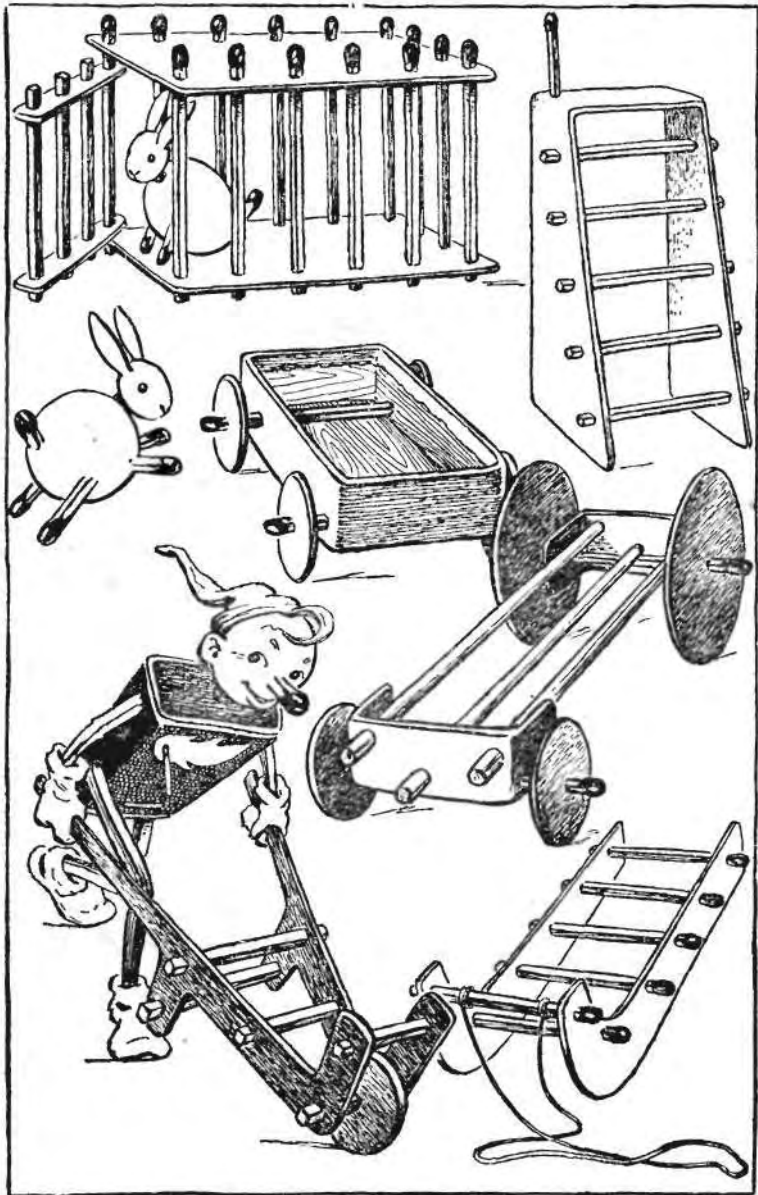



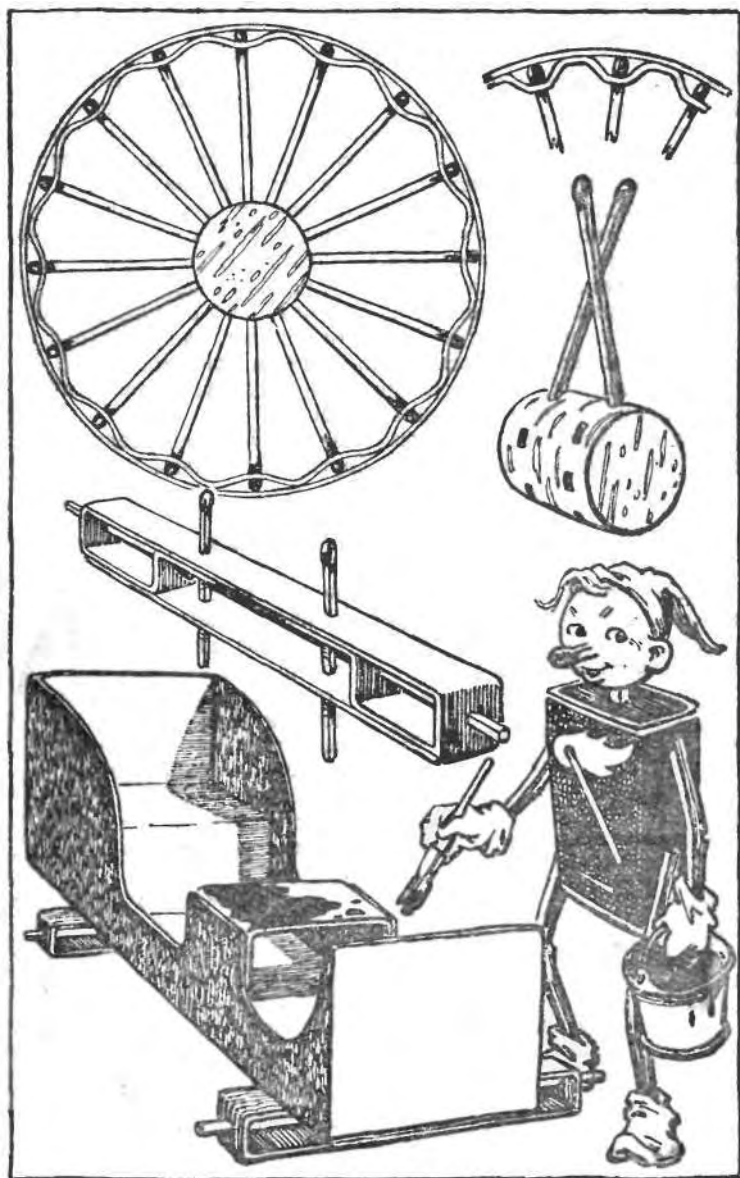

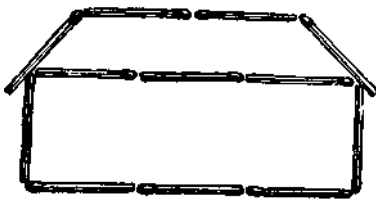

. 347.

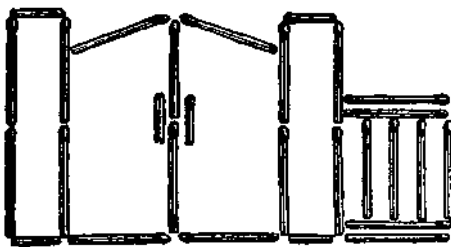

. 348.

(. 347),
(. 348),
(. 349),
(. 350).

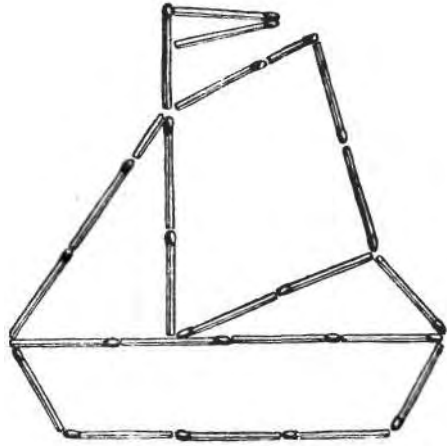

. 349.

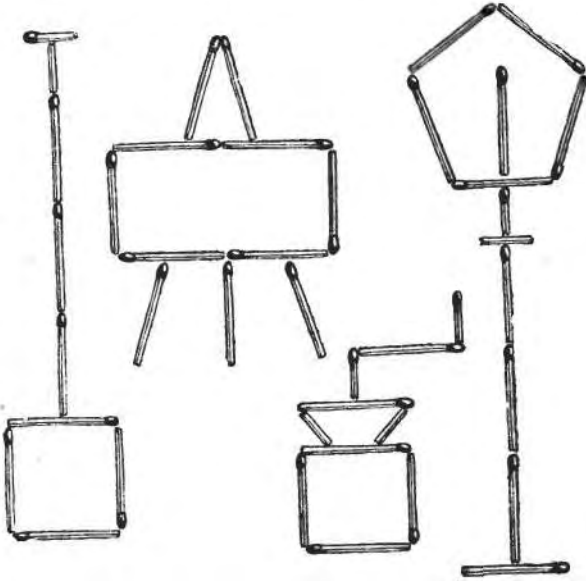

. 350.



(. 351)

(. 352),

. 351.

(. 353).
 ()
 (),
 ().



. 351.

(. 354).



. 352.

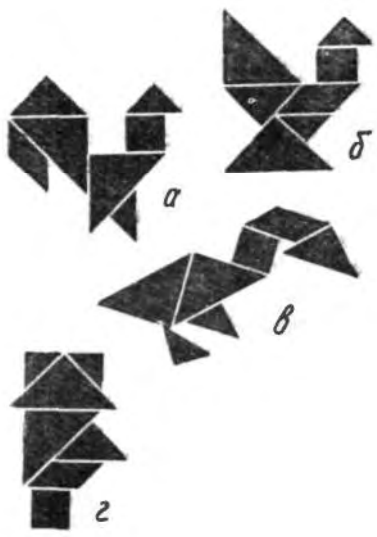

. 353.



. 354.
 (6), (9), (12) (10), (13), (11),
 (1), (2), (3), (4), (5), (8),
 (15), (14), (16), (17),
 (19), (18), (20), (21), (22), (23),
 (24), (25),
 . 490—494 :

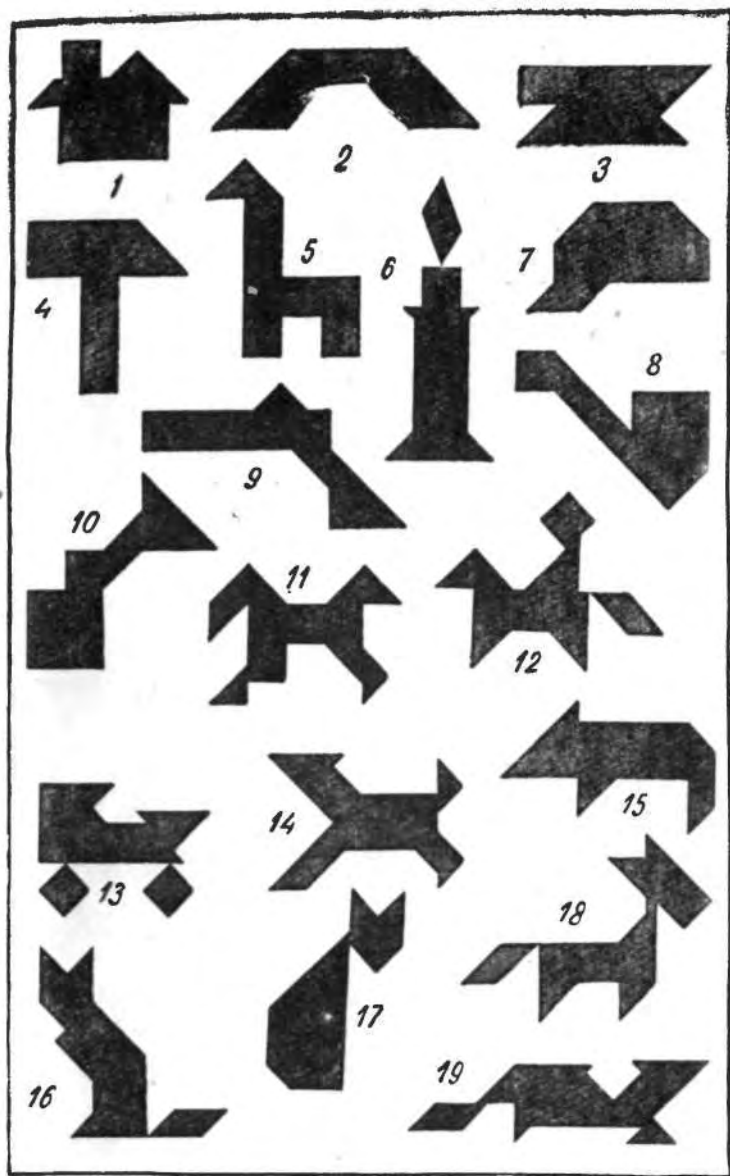

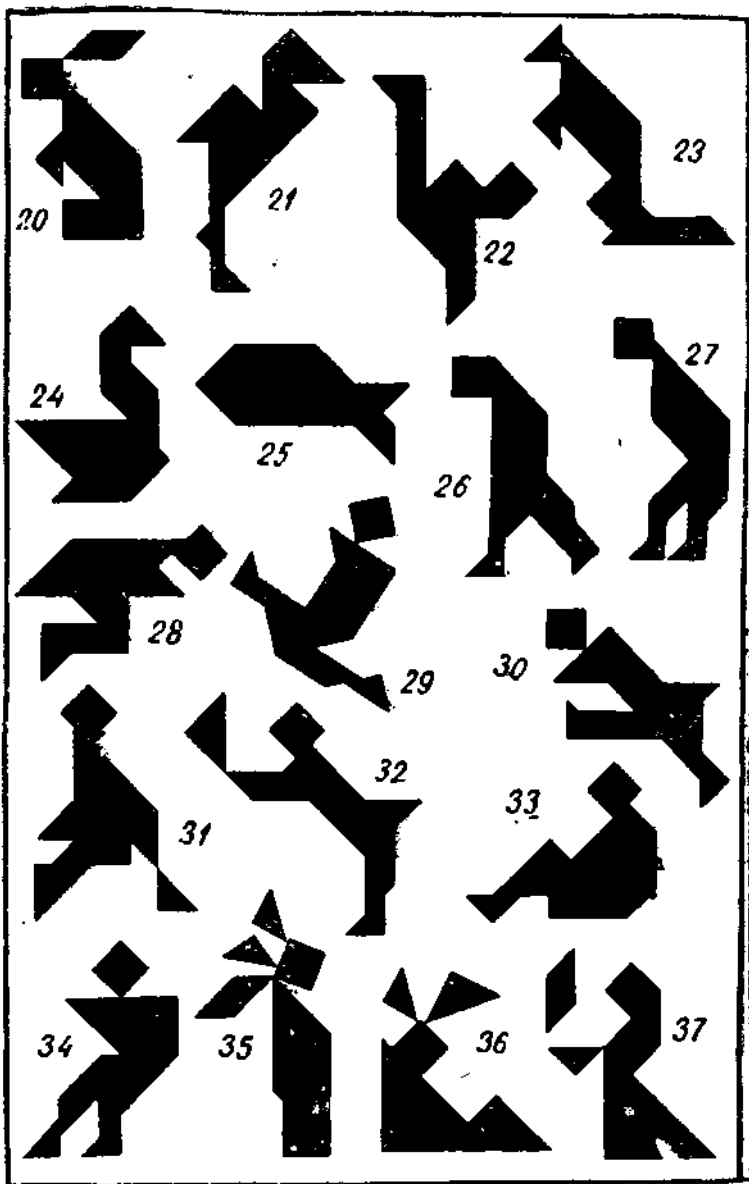

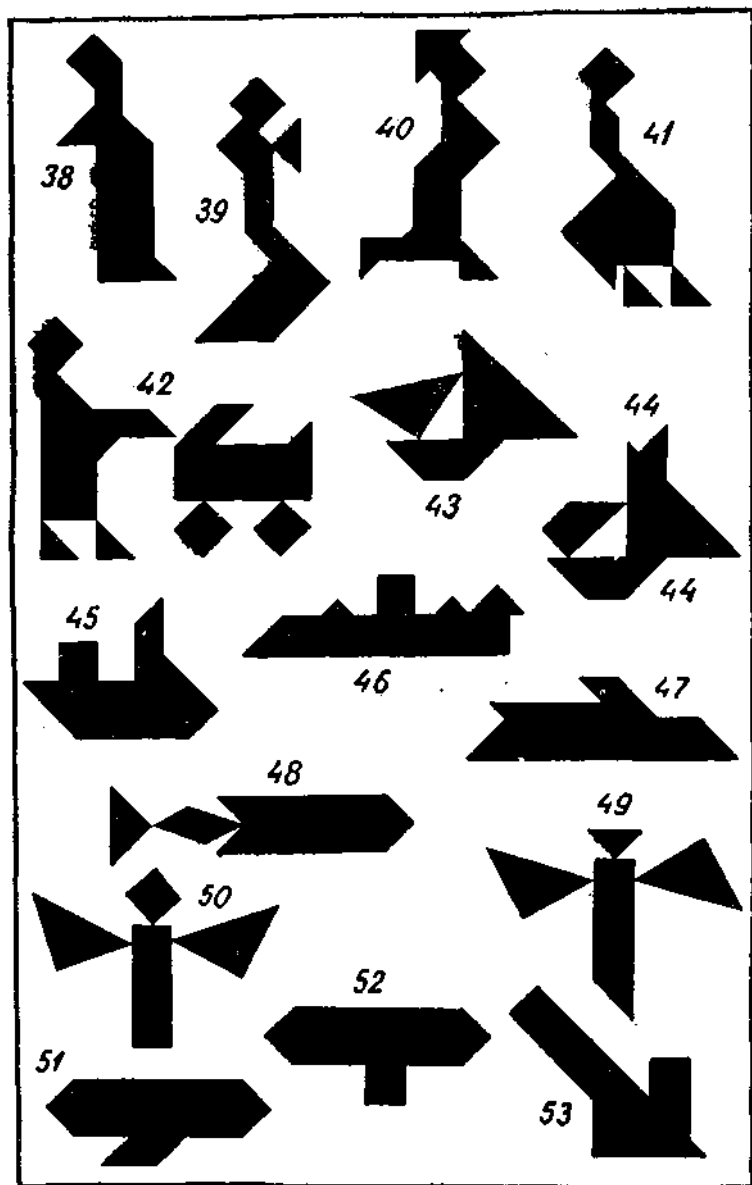

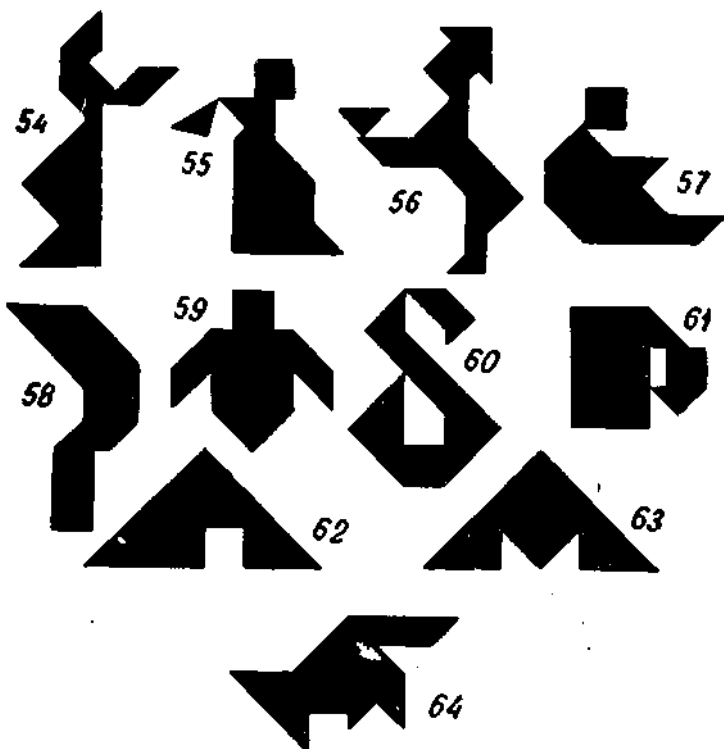

. 358.

(26).

(28)

(29)

(33).

(36).

(34),

(27).

(32),

(30)

(35)

31).

(. 357, 38), (40), (41). (37), (39),

(42). (. . 355, 13).

(43), (44) (45),

(46), (47), (48),

(49 50), (51 52), (53).

(. 358). (54),

(55), (56),

(57), (58), (59), (60),

(61), (62, 63) (64).

;

— ,

— , (. 359, 65).

(. 360, 66).

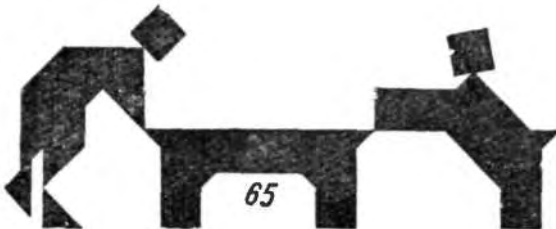



.360.



.361.

(.361, 67).

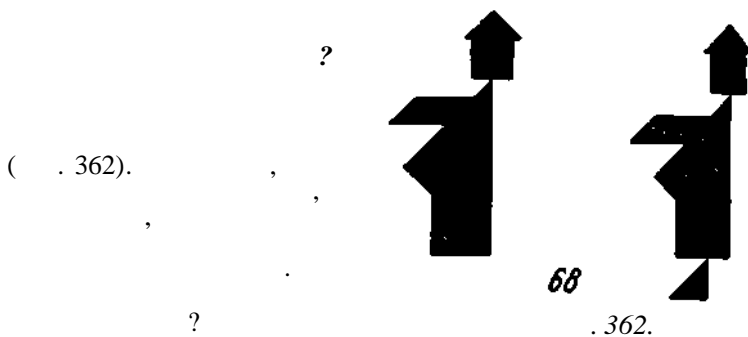

(.362).

.362.

— , ?

; , « : 4000 ».

— , —

— ?

— : ? ?

(. 363, 69, 70, 71 72).

) (, ? ?

— (. 363, 73).

(74), . 363,

(75) ?

(. 363, 76).

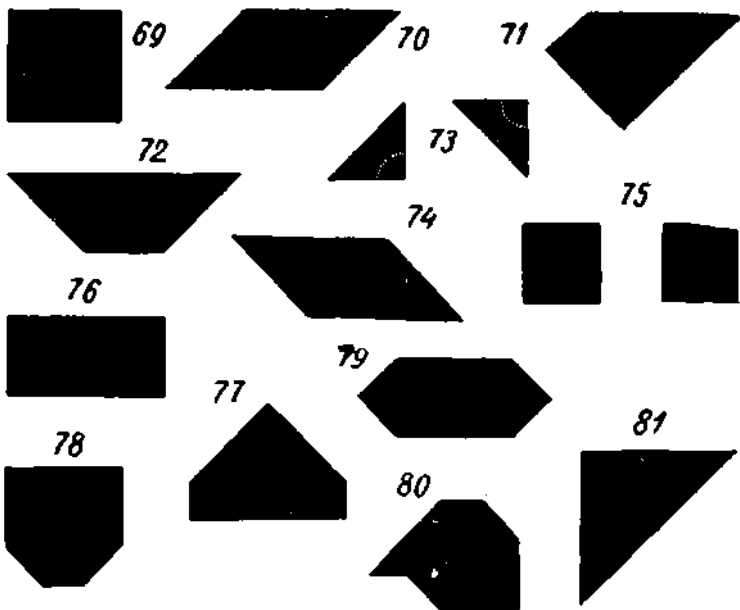

. 363.

(77)?

(79)?

(78)?

(80).

(81).

() .) .

1 1/2

?

».

**
*

(. 364).

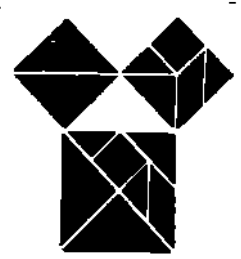

. 364.

—« ».

. 490—494
,—

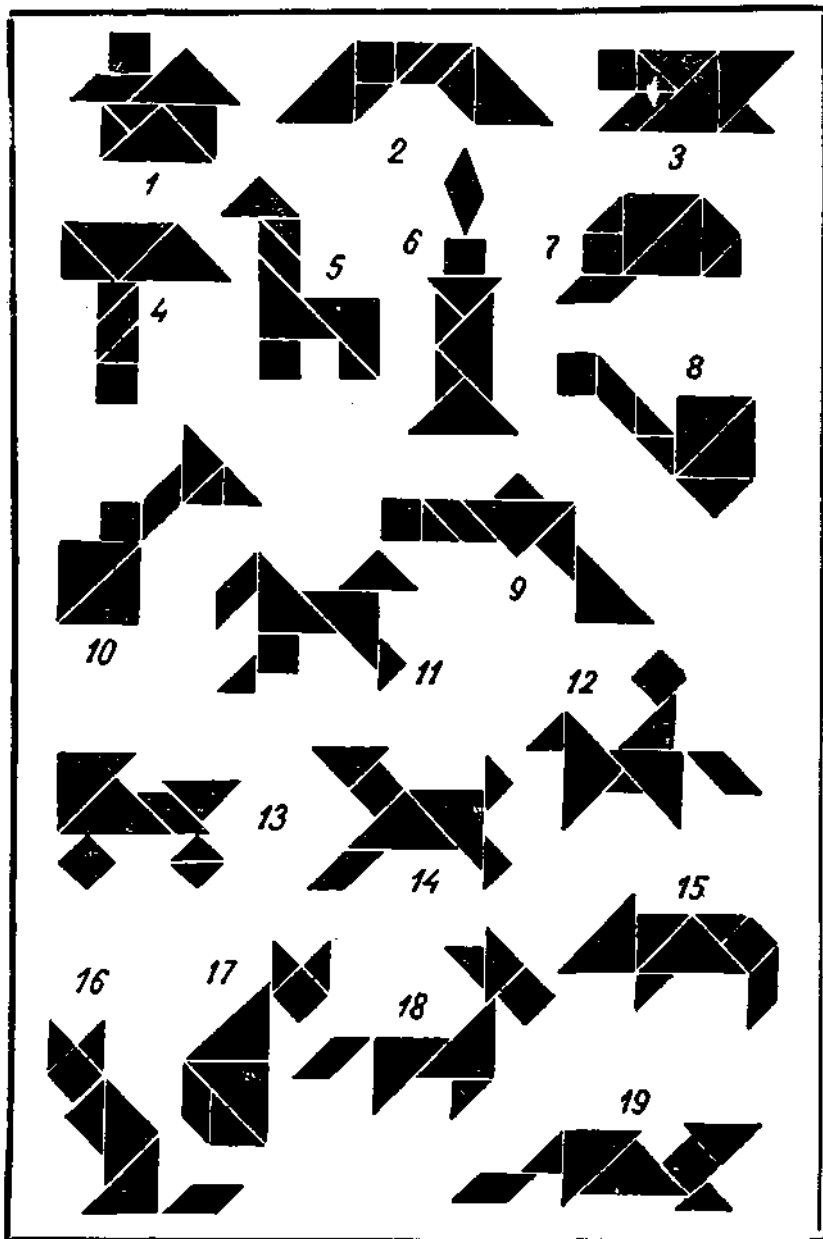

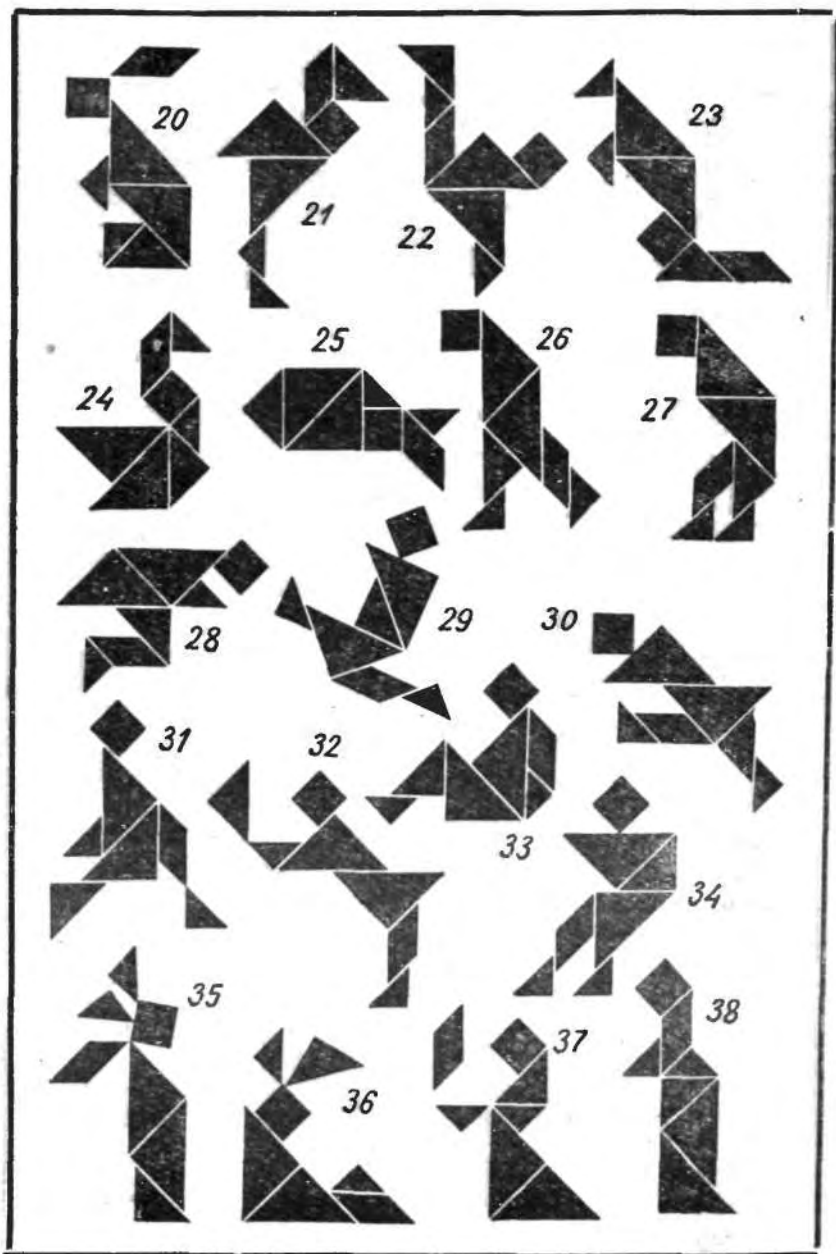

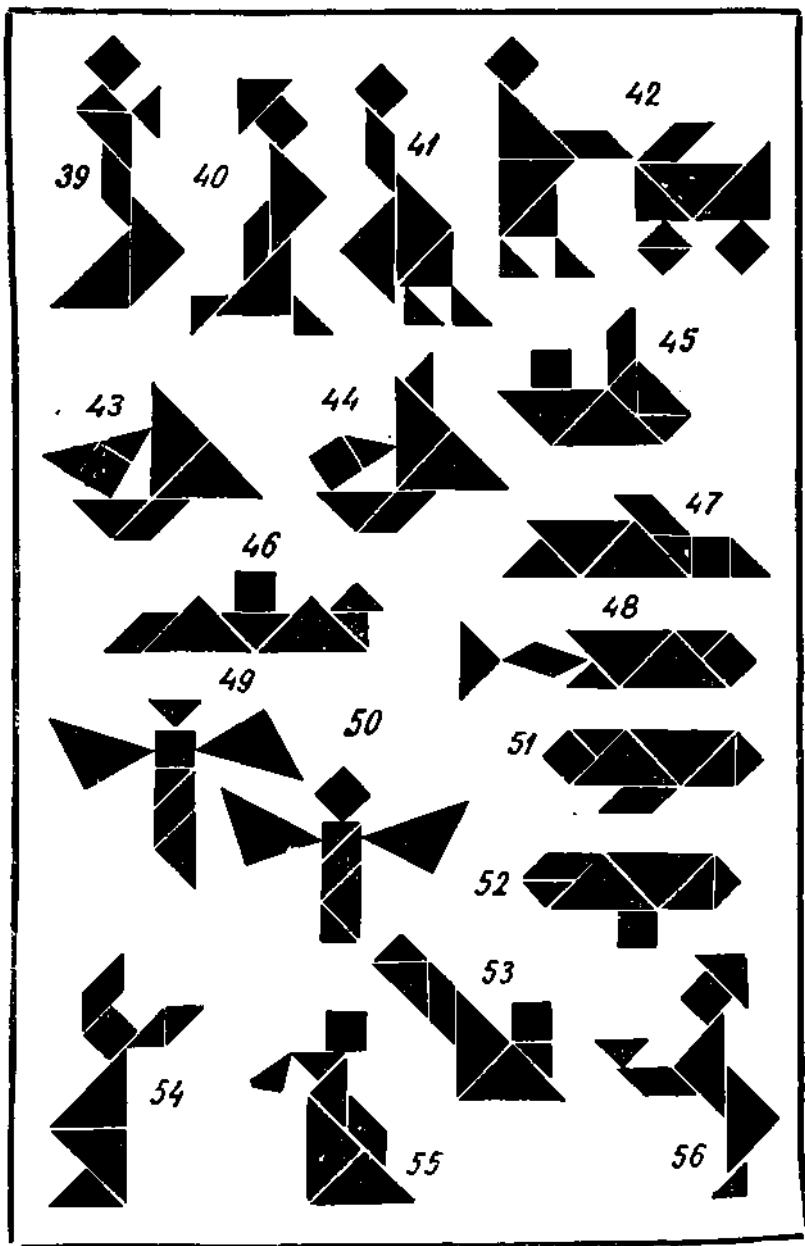

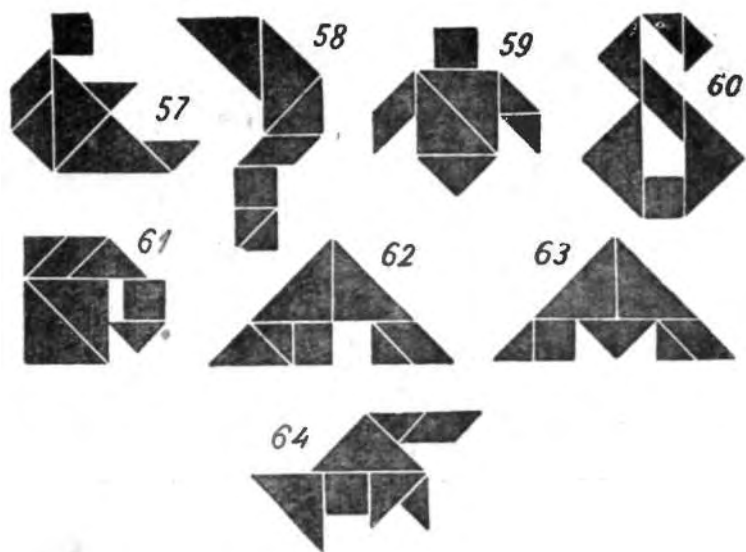

. 368.

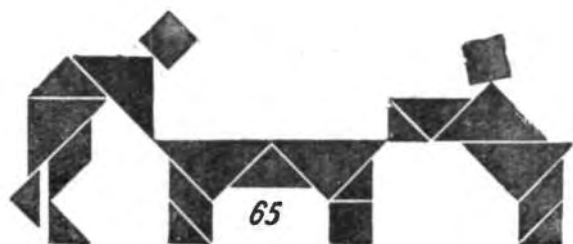

. 369.



. 370.



. 371.

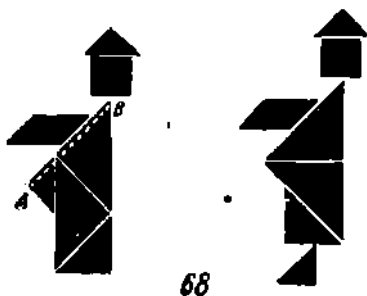

. 372.

?

. 372

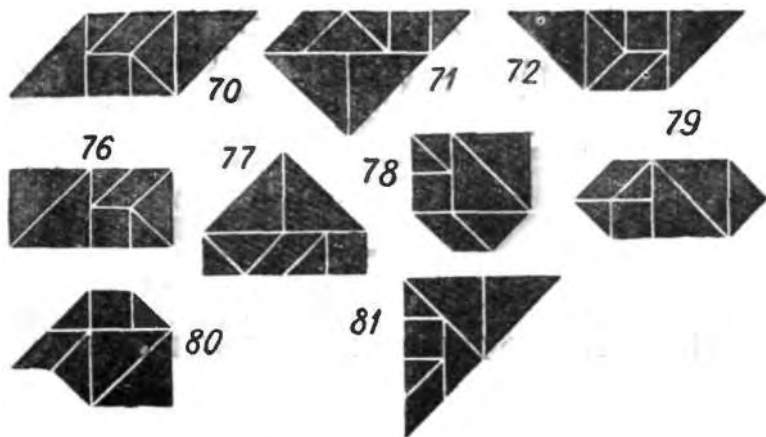

.373.



20

?

. 374.

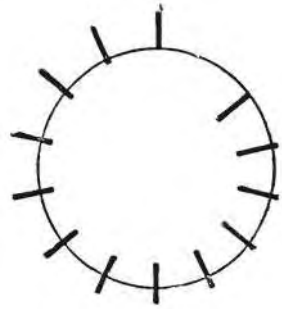

. 374.

13

12.

?

?

30

(. 375)

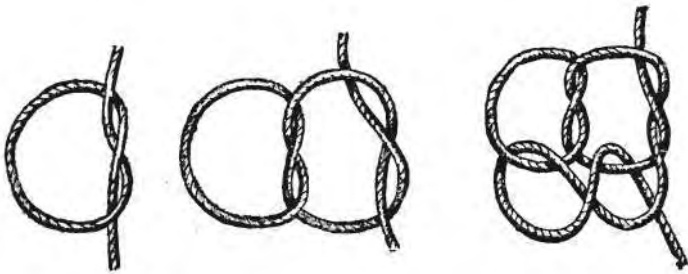

. 375

. 377.

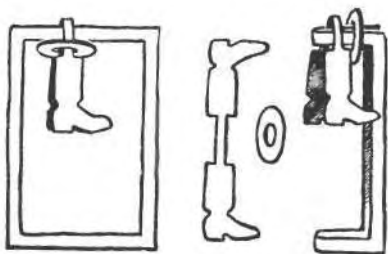

. 377.

(. 378).



. 378

?

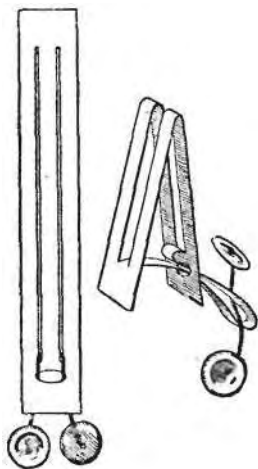

. 379.

. 379,

()?

”

”

7

5

().

. 380;

»

«

?

10

«

»

?

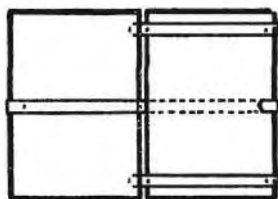

. 380.

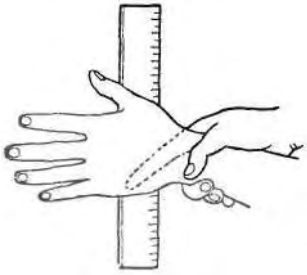

. 381.

. 381.



. 382.

382, « »



(

. 383).



. 384.

. 385,

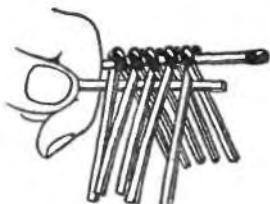
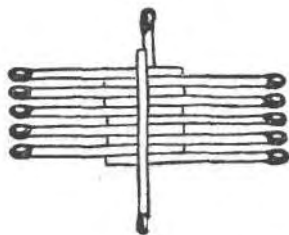

. 385.

? (. 386):

?



.386.

, : , ? -
 -
 -
 (.387). 10×10 -
 , , 3, 3 -
). -
 ; , , -
 — , -
 ; -
 ; -
 , -
 , , , -
 , , , -
 ; -
 , : 5, 2 9. -

I ()

(,),

): (

III ()

: 6, 4, 8.

I (

)

а б в г д е ж з и к

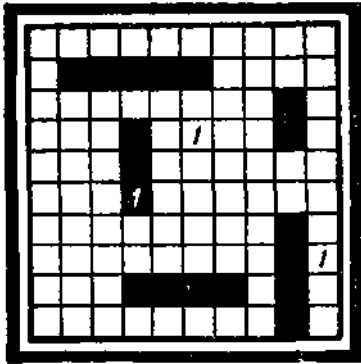

а б в г д е ж з и к

- 1
- 2
- 3
- 4
- 5
- 6
- 7
- 8
- 9
- 10

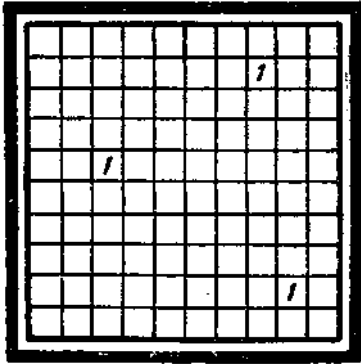

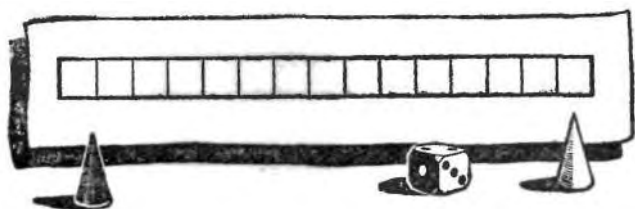

.388.

?

).

(

» « » « » « » « »

1

10

« » : « »

:

,

,

,

,

,

.

. « » « », , -
 , « »: « »
 « », « », « », « »
 « » , « »
 « »
 -
 -
 .
 , -
 :

<p>1. ,</p> <p>2. ,</p> <p>3. ,</p> <p>4. ,</p> <p>5. ,</p>	<p>6. ,</p> <p>7. ,</p> <p>8. ,</p> <p>9. ,</p> <p>10. .</p>
---	--

-

-

.

:

.

».

.

:

:

:

« » 150. -
: , -
.
, , « » -
, « », « -
» . « : « », « », -
« » . .

« ».

».

» — « »).

« », (« » — « -

- I
- II
- III
- IV
- V

VI
 ,
 VII
 ,
 VIII
 — , —
 ,
 IX
 :
 ,
 X
 , ?
 VII, VIII IX

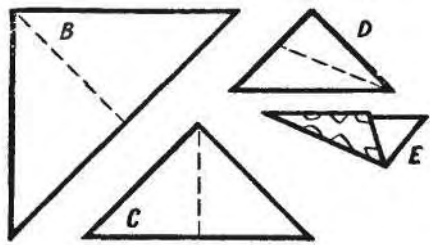
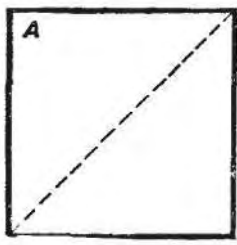

. 389, , , , D .

. 389.

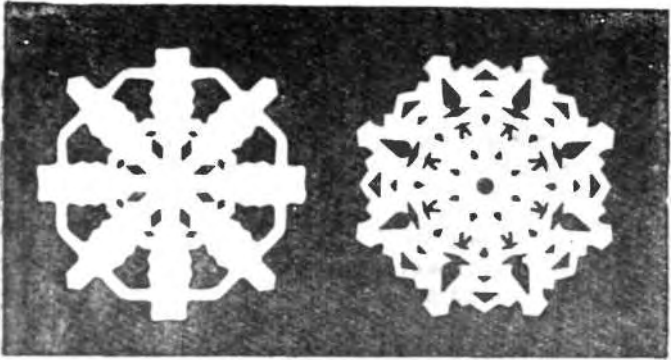

. 390.

, , -
 , , (. 390).

? : -
 , -
 , -
 . 391, . ? -
 , -

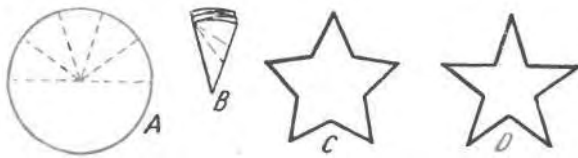

. 391.

391,

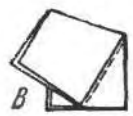
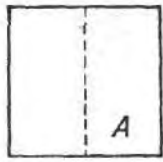

D),

(. 391,

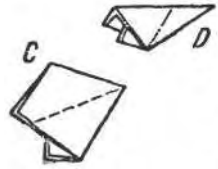

(. 392,)

. 392.

D.

. 392, D

. 392,

. 392, .

?

(. 393)

?



. 393.

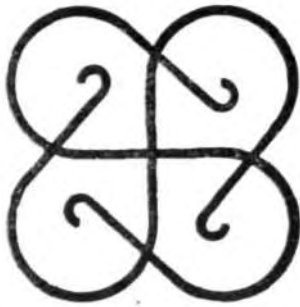

. 394.



. 395.

(. 396)

(. 394);

?..

?

(. 395)?

: «
?»

?



. 396.

, ' ? :

?

(. 397)?

e.



. 397.

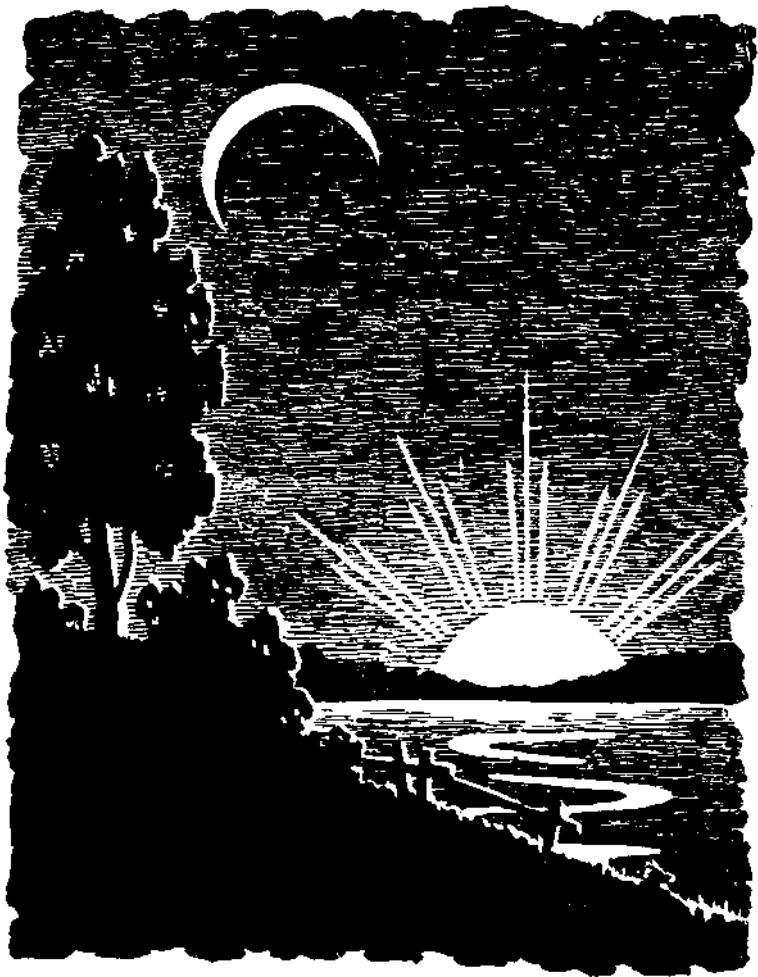

. 398.

(. 398) —
?



. 399.

. 399

?

?

-

-

« », « » 1
 « », « » « 2
 « », « » « 3
 « », « » « 4
 « », « » « 5
 « », « » « 6

4—3.

— « 4—3. » : « »—4, « »—3;

1—5,

— 4—2.
?

— 0—4,

0—4.
?

1	2
2	3
1	4
	4

20

« » « », — . : « » . 20 : « » . 24 30 () .

. 400

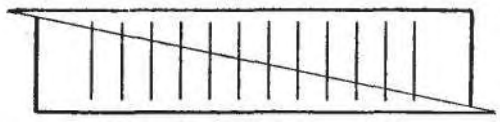
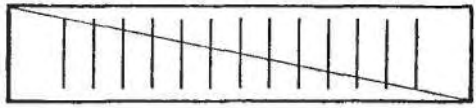

. 400.

13

12:

13

12

— 12 12 , -
 (. . 374),
 12 13 :

401),



. 401.

1. ,
2. ,
3. ,
4. ,
5. ,
6. ,

7. , 9. ,
 8. ; 10. .
 , , ,
 () « » () « » () « » () .

- I. . , , ,
- II. . , « », -
- III. . ;
- IV. . , -
- V. .
- VI. () .
- VII. .
- VIII. (« »), -
- IX. , .
- X. , .

?

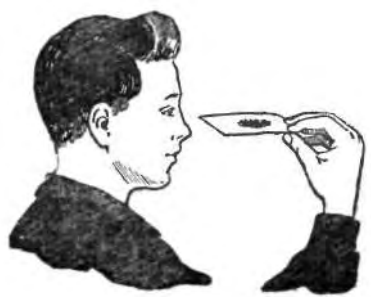

. 402.

, .402.
 -
 « », ,
 — « ».
 -
 ,
 ,
 ,
 .

. 399.

	5
.....	28
.....	71
.....	88
.....	140
.....	169
.....	187
.....	195
.....	201
.....	208
.....	217
.....	228
.....	238
.....	243
.....	252
.....	266
.....	279
.....	294
.....	322
..... ?	339
.....	344
.....	352
.....	365
.....	408
.....	416
.....	440
.....	445
.....	478
.....	496

, 43. : , 47. -

33 6/II 1959 (24,96 . . .). 70 000 29/VI 1959 03875. 10 60×92¹/₁₆ —
1. , 49 1592.